



# A4

The all-new A4 Saloon and Avant

# Contents

This guide is designed to help you explore the features and options of the all-new Audi A4. You can also configure your perfect A4 using our online configurator, at [configurator.audi.co.uk](http://configurator.audi.co.uk)

## Page 4

The all-new Audi A4

---

## Page 28

Vorsprung durch Technik in your Audi A4

---

## Page 48

Build your A4

Create the car you always imagined.

|                            |                |                                      |                 |
|----------------------------|----------------|--------------------------------------|-----------------|
| Model choice               | <b>Page 50</b> | Interior inlays                      | <b>Page 84</b>  |
| Paint                      | <b>Page 62</b> | Interior equipment                   | <b>Page 86</b>  |
| Wheels                     | <b>Page 64</b> | Technology Packs                     | <b>Page 90</b>  |
| Performance and suspension | <b>Page 66</b> | Technology - Audio and communication | <b>Page 96</b>  |
| Lighting                   | <b>Page 68</b> | Technology - Driver assistance       | <b>Page 100</b> |
| Exterior equipment         | <b>Page 70</b> | Audi Genuine Accessories             | <b>Page 106</b> |
| Seating and upholstery     | <b>Page 74</b> | Audi warranty                        | <b>Page 107</b> |

---

## Page 108

Audi glossary

---

## Page 112

Technical specifications and dimensions

---

## Page 116

Buying and maintaining your A4

|                     |                 |                       |                 |
|---------------------|-----------------|-----------------------|-----------------|
| The Audi Difference | <b>Page 122</b> | Important information | <b>Page 124</b> |
| Financing your Audi | <b>Page 123</b> |                       |                 |



# The all-new Audi A4

Lighter. More agile. More advanced. We've enhanced every part of the all-new Audi A4, bringing new features to the cabin and more power under the bonnet. The design is refined and the engineering smarter, with more precise details and a range of updated engines and transmissions. Advanced technology. Cutting-edge design. The only thing that hasn't changed is the name.





# The Exterior

**Poise, elegance, precision.**

The lines are sharper. The shape is bolder. The stance lower. From the shoulder line that runs the length of the car, to the detailed styling of headlights and sculptured air intakes, the all-new A4 has a new, distinctive presence.



**Dynamic, sporty, streamlined.**

Thanks to advanced engineering and manufacturing, the gaps between body panels are now incredibly tight. The effect is a seamless flow of contours, evident in every detail. Making the all-new A4 one of the most precisely engineered cars in its class.







# Performance

**Agility and comfort at every turn.**

Redesigned engines. Enhanced transmissions. Finely tuned suspension options. Our latest developments come together to create a car that's more than the sum of its parts. The 7-speed S tronic transmission offers more sporty settings, while the completely new five-link front and rear suspension gives unprecedented agility and comfort on the road.





### Lighter than ever. And more powerful.

We've made the all-new Audi A4 up to 120kg lighter than its predecessor and even more fuel-efficient. Yet every engine option is now also more powerful. It's not because of just one change; rather, it's the result of hundreds of improvements we've made throughout the car.









# The Interior

**A cabin that surrounds you.**

With its unique wraparound design and improved headroom, the interior of the Audi A4 provides a feeling of space and safety. The air vents and 3D inlay run the width of the cabin in a long, unbroken line. The plunging centre console lends a 'floating' aspect to the low-profile dashboard with its large, yet slimline MMI display. And small details add to the feeling of refinement, like touch switches for the climate control or the gear lever that also acts as a hand rest for the MMI system.



### Quietly brilliant.

The Audi A4's improved aerodynamics don't just reduce fuel consumption, they also cut out road noise for a whisper-quiet cabin. More spacious than its predecessor, passengers in the front and rear are immersed in a feeling of comfort. There's extra room for cargo too, with a redesigned boot. In fact, the A4 Avant has more luggage space than any other car in its class.





# Technology

Bring your A4 to life.

It's the latest innovations that really set this car apart. Audi Virtual Cockpit, which transforms the instrument cluster at the touch of a button. Driver assistants, that watch the road intelligently. A head-up display, that puts the information you want right where you need it. All available as options, they represent the very pinnacle of Audi technology.

# Vorsprung durch Technik



## **Not just a slogan. A philosophy.**

Progress. It's behind everything we do at Audi. It's why we're always developing new technologies to help you on the road and new engines to deliver enhanced performance and economy. Because we know we're defined not by what we've done, but what we do next.

The all-new Audi A4 is the embodiment of this approach.



# quattro

## **Exceptional road holding whatever the road holds.**

Loose gravel. Icy patches. A tight bend in the rain. Conditions on the road are always changing, so quattro® changes too. Available on a variety of A4 Sport and S line engines, it analyses your grip – automatically distributing power between all four wheels to where it's needed most. It's made for the most challenging conditions of all - the ones you encounter every day. Whatever the road holds, you can be confident that quattro will react.





## More from less.

At Audi, using less is something we're trying to do more of. We're constantly working to ensure our cars use less fuel, release less CO<sub>2</sub> and waste less energy. Audi ultra is the realisation of this aim. Turning sustainability and efficiency into the driving forces behind "Vorsprung durch Technik", ultra brings together new materials and intelligent technology to create some of the most efficient and sustainable cars in their respective classes.

In the all-new Audi A4, this means saving 120kg in weight, thanks to an intelligent use of materials. The body, for example, is a combination of hot-formed steel and aluminium. It means reduced drag and minimal wind noise, with class-leading aerodynamics. It also means advanced features as standard, like cruise control with free-wheeling mode. And Start-Stop technology, that now also cuts off the engine when slowing down before you reach the lights – as well as when you're stationary – to save fuel.

Overleaf, you'll find more details on our Audi A4 ultra models that not only feature all the characteristics above but are also the most efficient models in the A4 range and offer the lowest CO<sub>2</sub> emissions. Earning them the right to wear the ultra badge.

ultra



CO<sub>2</sub>  
from  
99g/km

BIK  
from  
17%



up to  
74.3mpg  
combined

## All-new Audi A4 ultra models

The all-new Audi A4 ultra is available on Saloon and Avant. Both models offer highly efficient 150PS or 190PS 2.0 TDI engines, as well as the choice of 6-speed manual and, for the first time, 7-speed S tronic® transmissions.

Audi ultra engines are faster and more powerful and emit up to 8% less than their predecessors. Across Saloon and Avant SE and Sport models, 12 variants are available, with CO<sub>2</sub> emissions from as low as 99g/km, breaking the critical 100g/km threshold.

Put simply, with the A4 Audi ultra models, there's no need to compromise on power, efficiency or specification. As you'll see from the figures here.



All mpg shown are combined mpg. ultra TDI models come with a 40 litre fuel tank and a 12 litre AdBlue tank as standard. A larger 54 litre fuel tank and 24 litre AdBlue tank are available as free of charge options - see page 70. ultra TDI models come with 17" low rolling resistance tyres. \*Source: Manufacturer Price Lists (September 2015)

## A4 Saloon ultra

There is an ultra model for every need. The most economical engine is the 150PS, but if you'd like more power and acceleration, the new 190PS engine delivers efficiency - without compromising performance.

| 2.0 TDI 150PS           |                          | 2.0 TDI 190PS            |                          |
|-------------------------|--------------------------|--------------------------|--------------------------|
| Manual                  | S tronic                 | Manual                   | S tronic                 |
| 99 CO <sub>2</sub> g/km | 101 CO <sub>2</sub> g/km | 102 CO <sub>2</sub> g/km | 103 CO <sub>2</sub> g/km |
| 17% BIK                 | 18% BIK                  | 18% BIK                  | 18% BIK                  |
| 74.3 mpg                | 72.4 mpg                 | 72.4 mpg                 | 70.6 mpg                 |

BIK  
from  
17%

CO<sub>2</sub>  
from  
99g/km

up to  
74.3mpg  
combined

## A4 Avant ultra

With the lowest CO<sub>2</sub> emissions and fuel consumption available when fitted with 17" wheels, the entire Avant ultra range leads its class.\* So now, you can have space and performance, without sacrificing efficiency.

| 2.0 TDI 150PS            |                          | 2.0 TDI 190PS            |                          |
|--------------------------|--------------------------|--------------------------|--------------------------|
| Manual                   | S tronic                 | Manual                   | S tronic                 |
| 104 CO <sub>2</sub> g/km | 104 CO <sub>2</sub> g/km | 106 CO <sub>2</sub> g/km | 106 CO <sub>2</sub> g/km |
| 18% BIK                  | 18% BIK                  | 19% BIK                  | 19% BIK                  |
| 70.6 mpg                 | 70.6 mpg                 | 68.9 mpg                 | 68.9 mpg                 |

BIK  
from  
18%

CO<sub>2</sub>  
from  
104g/km

up to  
70.6mpg  
combined



# LED lights

## **Illuminating features.**

The Audi A4's optional new, cutting-edge Matrix LED headlights produce a light similar in colour to daylight. They also incorporate sensors and an inbuilt camera that detects other road users, as well as ambient light in built-up areas. They then react by dipping individual LEDs to prevent dazzle, while still fully illuminating the remainder of the road.

Where available, Matrix LED technology will even use the vehicle's navigation data to anticipate corners, adjusting LEDs as you negotiate the bend. The result is a much wider visual range, benefiting both you and other road users. Dynamic sweeping indicators complete the striking look at the front and rear.



## Bring your phone to the fore.

Imagine being able to use your smartphone applications, even while driving. The Audi Smartphone Interface, standard on the Audi A4, lets you do just that.

Satellite navigation. Music streaming. Your contact list. Now you can access apps, approved for in-car use by Android and Apple, from the MMI controls on the A4's centre console, from the multi-function steering wheel, Audi Voice Control, or even via your smartphone's assistant, like Siri.

Simply connect your phone via USB\* and approved apps appear in full colour on the central MMI screen.



# Smartphone Interface

# Smartphone Interface

## Finding your way



You can now use your Apple and Google maps\* as your navigation system. Turn-by-turn directions, traffic guidance and estimated arrival times are easy to see on your MMI screen without having to touch your phone – and addresses from your email, texts, contacts and calendar can be added as destinations. Don't forget planning your journey at home reduces data usage while on the move.



Apple and Google Maps\*

## Your own soundtrack



You can play music stored on your phone as you drive, controlling it simply and intuitively through the interface. Streaming services are also available, including Spotify and Google Play Music\* (90-day free trial included with Android Auto).



Spotify, Apple Music and Google Play Music\*

## Keeping in touch



With Audi Smartphone Interface, any text messages you receive while driving can be read out to you – and if you need to respond, you can do so simply by dictating your message. But not only that. You can also use approved 3rd party apps\* like WhatsApp to keep in touch while driving.



WhatsApp, Skype and Google Hangouts\*

## What's on your phone is now available on the road.

The Audi Smartphone Interface makes linking your phone to your car quick, safe and easy.

With Android Auto and Apple CarPlay, you can access approved apps\* from your phone safely via the Audi A4's MMI system – both by voice or fingertip control. So you can make calls, receive and dictate messages, navigate, select music and podcasts and much more without taking your eyes off the road.

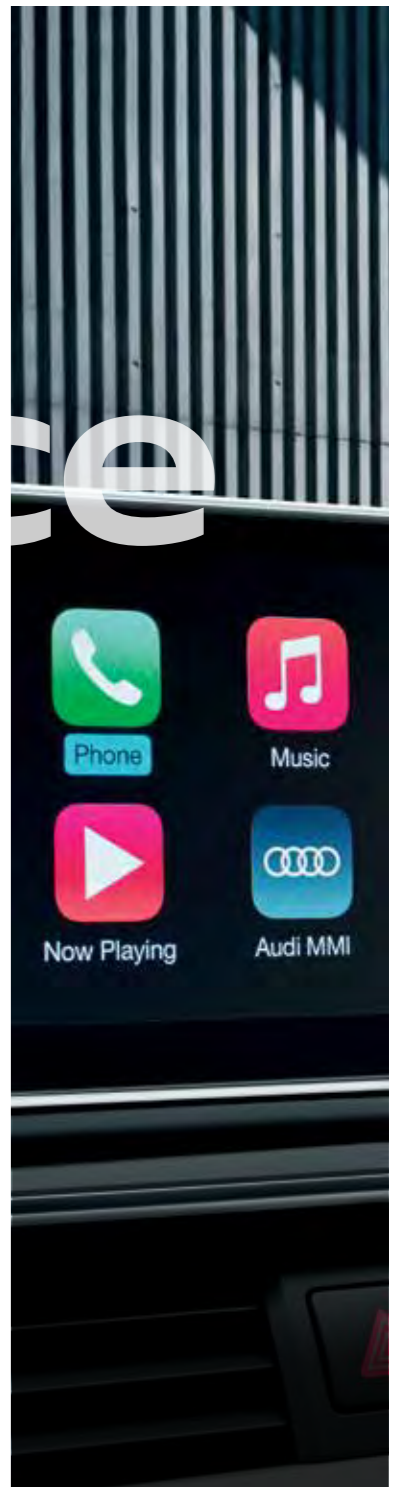

\*Availability of applications differ by operating system and is dependent on approval by Apple or Google. Permanent availability cannot be guaranteed as this is the responsibility of Apple and Google. Smartphone Interface uses Apple CarPlay, which is available with iPhone 5 and above, or Android Auto, which is available with phones using Android 5.0 Lollipop or above.



# Audi connect

## The world at your fingertips.

Audi Connect is the link between your Audi and the internet, giving you access to entertainment, information and search functions via scrolling, tapping or verbal commands.

With high-speed 4G internet access in your car,\* you can call up flight information, fuel prices and weather, as well as high-resolution aerial and satellite pictures from Google Earth™ and Google Street View™. It also features an in-car wireless hotspot, allowing passengers to access their mobile devices, connecting you to the journey ahead, and your world beyond.

\*Please note that an external data source is required to enable Audi Connect online services.



Audi  
Connect

## Stay connected on the move.

The following Audi-supported services are currently available in the all-new Audi A4:

### Infotainment



**Online media streaming** Pairing a smartphone with the Audi Music stream app offers access to worldwide radio stations and music stored on the smartphone



**Weather information** Gives you forecasts and maps for your chosen destination



**News online (individual)** Text and images from your favourite news sources with text-to-speech function



**Country-specific information\***  
The legal regulations for a specific country, such as speed limits or whether it is compulsory to carry a high-visibility vest or display a motorway toll sticker, are displayed when crossing a border

### Communication



**Wi-Fi hotspot** Connects your mobile devices to the internet



**Twitter** Enables you to tweet and receive updates on the move. With text-to-speech and other convenient text functions



**Email** Your emails can be transmitted to your Audi MMI and read out conveniently\*\*

### Mobility and navigation



**Points of interest**  
Search Google™ using voice control



**Navigate with Google Earth™ and Google Street View™**  
Uses high-resolution aerial and satellite images as well as photos to guide you to your destination with ease



**Destination entry via myAudi or Google Maps™**  
If required, navigation destinations can be conveniently planned on your PC or smartphone. myAudi and Google Maps™ allow individual navigation destinations to be sent to the vehicle. When you start your journey, these can be easily loaded as your destination. myAudi or Google account required



**myAudi – special destinations\***  
Import individual point-of-interest (POI) lists to your Satellite Navigation system via the myAudi portal



**Map update online** The map version delivered can be updated free of charge with the first 5 navigation updates which are issued at intervals of 6 months. In conjunction with Audi Connect, the update can be carried out online in the vehicle\*



**Flight information** Get information about departure and arrival times, as well as the corresponding gates, and search directly for flight numbers



**Train information** Find departure and arrival times and platform information while you're on the road (also available for other types of public transport such as underground systems)



**Fuel prices** Information on filling stations with the cheapest prices in your selected search area



**Parking information** Helps you find car parks nearby and, where available, information on prices and currently vacant spaces



**Traffic information online** Complements the dynamic route guidance with real-time traffic flow information for individual stretches of road

Please note that an external data source is required to enable Audi Connect online services.

Terms and conditions apply to certain Audi Connect functions. Please see page 125 for additional information.

\*For information about compatible phones please visit [www.audi.com/bluetooth](http://www.audi.com/bluetooth)

\*\*Only available when ordered in combination with Technology Pack (WB4)

## Customisable control.

The information you need is always changing, so the Audi Virtual Cockpit changes too. Available as an option, it replaces the traditional dashboard with a high resolution, 12.3" LCD screen, which you can customise just by pressing the 'view' button on the multi-function steering wheel. Choose the 'classic' view, with prominent speedometer and rev counter, or the 'infotainment' view, which brings functions such as the navigation map or media to the fore - with crisp 3D graphics and highly detailed effects.

Everything you need to know right in front of you: it's the embodiment of Vorsprung durch Technik.





# How to build your Audi A4

Choose your trim and body style then select your options.

The following sections of this guide are designed to make it easy for you to create the Audi you've always imagined.



## Stage 1. Model choice

Choose your trim for your A4 Saloon or Avant  
Page 50



## Stage 2. Paint

Standard, optional or Audi exclusive  
Page 62



## Stage 3. Wheels

17", 18" and 19" alloy wheels  
Page 64



## Stage 4. Performance and suspension

Steering and suspension Page 66



## Stage 5. Lighting

Advanced lighting technology options  
Page 68



## Stage 6. Exterior equipment

Options for exterior finishing touches  
Page 70



## Stage 7. Seating and upholstery

Seats, colours and trim options  
Page 74



## Stage 8. Interior inlays

Standard or optional  
Page 84



## Stage 9. Interior equipment

Options for interior finishing touches  
Page 86



## Stage 10. Technology Packs

Advanced Technology options,  
bundled for value  
Page 90



## Stage 11. Technology – Audio and communication

Options for music, entertainment  
and information Page 96



## Stage 12. Technology – Driver assistance

Advanced options for safety and visibility  
Page 100

# A4 SE

## Key features that come as standard.

SE offers premium specification as standard. Highlights include Xenon headlights with LED daytime running lights, Audi Smartphone Interface, 3-zone climate control and a 7" colour MMI monitor. In Avant versions, a power operated tailgate and an electrically retracting luggage cover are also standard, facilitating access to the most accommodating load bay in the premium compact executive estate class.

### Wheels

- ▶ 17" '10-spoke crystal' design alloy wheels
- ▶ ultra TDI models come with low rolling resistance tyres
- ▶ Space-saver spare wheel
- ▶ Tool kit and car jack

### Performance and suspension

- ▶ Automatic Start-Stop with coasting functionality and efficiency programme
- ▶ Electromechanical power steering
- ▶ Comfort Dynamic suspension (ultra TDI models come with Sport suspension)
- ▶ Audi Drive Select

### Lighting

- ▶ Xenon headlights with LED daytime running lights

### Exterior

- ▶ Radiator grille in Titan black with chrome inlays
- ▶ Air inlets in Titan black
- ▶ Door handles with chrome inlay
- ▶ Rear diffuser in Titan black, matt
- ▶ Rear diffuser clip in chrome

### Exterior continued

- ▶ Chrome-plated exhaust trims
- ▶ Aluminium roof rails (Avant models only)
- ▶ High gloss package - roof frame and window trims in Aluminium, B-pillar trims and triangular rear door trim in High-gloss black
- ▶ Door mirrors – electrically adjustable and heated with integrated LED side indicators
- ▶ Body coloured door mirrors
- ▶ Tow bar preparation
- ▶ Windscreen with acoustic glazing

### Seats

- ▶ Standard seats in Concept cloth
- ▶ Manual seat adjustment

### Interior Inlays

- ▶ Inlays in Aluminium Ellipse, silver

### Interior equipment

- ▶ Deluxe 3-zone electronic climate control

- ▶ 3-spoke leather trimmed multi-functional steering wheel with chrome clip (and paddles for automatic transmissions) – height and reach adjustable
- ▶ Door sill trims with Aluminium inlay
- ▶ Auto-dimming rear view mirror
- ▶ Front Centre armrest
- ▶ Split folding rear seat bench in 3 parts (40/20/40) with rear centre armrest
- ▶ Electric boot lid release – (Saloon models only)
- ▶ Power operated tailgate – (Avant models only)
- ▶ Electric load area cover – (Avant models only)
- ▶ Interior lighting

### Audio and communication

- ▶ MMI® Radio Plus with 7" colour MMI screen
- ▶ Audi Smartphone Interface
- ▶ Driver Information System – 5" monochrome display
- ▶ Voice control
- ▶ Bluetooth interface

- ▶ DAB digital radio reception
- ▶ 8 passive loudspeakers
- ▶ 2 USB charging ports
- ▶ CD drive
- ▶ Navigation preparation ('Ready 4 Nav')

### Driver assistance

- ▶ Cruise control system with speed limiter. Free-wheeling capability on models with automatic transmissions
- ▶ Rear parking sensors
- ▶ Keyless go
- ▶ Pre sense city
- ▶ Multi-collision brake assist

### Safety and security

- ▶ Pop-up bonnet for pedestrian protection
- ▶ Electronic Stabilisation Control (ESC), including ABS, ASR and EDL
- ▶ Light and rain sensor
- ▶ Anti-theft alarm
- ▶ ISOFIX child seat mounting and Top Tether
- ▶ 6 Airbag system
- ▶ Anti-theft wheel bolts
- ▶ First aid kit with warning triangle
- ▶ Seat belt monitoring

|                            | Petrol          |                 |                  | Diesel               |                      |
|----------------------------|-----------------|-----------------|------------------|----------------------|----------------------|
| <b>Engine</b>              | <b>1.4 TFSI</b> | <b>2.0 TFSI</b> | <b>2.0 TFSI</b>  | <b>2.0 TDI ultra</b> | <b>2.0 TDI ultra</b> |
| <b>Power</b>               | 150PS           | 190PS           | 190PS            | 150PS                | 150PS                |
| <b>Transmission</b>        | 6-speed manual  | 6-speed manual  | 7-speed S tronic | 6-speed manual       | 7-speed S tronic     |
| <b>Saloon</b>              |                 |                 |                  |                      |                      |
| <b>CO<sub>2</sub> g/km</b> | 126*            | 127*            | 116*             | 99*                  | 101*                 |
| <b>RRP</b>                 | £25,215         | £27,015         | £28,545          | £28,465              | £29,995              |
| <b>Recommended OTR</b>     | £25,900         | £27,700         | £29,230          | £29,150              | £30,680              |
| <b>Avant</b>               |                 |                 |                  |                      |                      |
| <b>CO<sub>2</sub> g/km</b> | TBC†            | 129*            | 121*             | 104*                 | 104*                 |
| <b>RRP</b>                 | TBC†            | £28,415         | £29,945          | £29,865              | £31,395              |
| <b>Recommended OTR</b>     | TBC†            | £29,100         | £30,630          | £30,550              | £32,080              |

Please see page 124-125 for explanation on Recommended On-The-Road (OTR) retail prices and VED rates. \*CO<sub>2</sub> emissions can change if a different size alloy is ordered onto the vehicle. This may lead to a change to the VED amount payable. Please refer to pages 64-65, 114-115, 118-119 and 125. Value based on standard EU test figures for comparative purposes and may not reflect real driving results. †To be announced closer to launch, models arriving April 2016. For more details on the items listed above, please see the Glossary on pages 108-111.

# A4 SE

Available as Saloon or Avant.



1.



2.

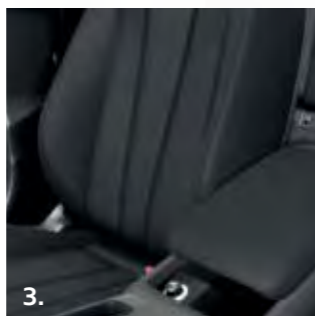

3.



4.

**Main image.** A4 Saloon SE in optional Manhattan grey, metallic (H1). 1. 17" '10-spoke crystal' design alloy wheels. 2. Xenon headlights with LED daytime running lights. Image also shows revised air inlet design when Adaptive cruise control is ordered. 3. Standard seats in Concept cloth. 4. Deluxe 3-zone electronic climate control.



5.



6.



7.



8.

**Main image.** A4 Avant in optional Manhattan grey, metallic (H1). 5. 3-spoke leather trimmed multi-function steering with paddles for automatic transmissions. 6. MMI Radio Plus with 7" colour MMI screen and Audi Smartphone Interface. 7. Audi Drive Select. 8. MMI controller with integrated joystick function.

# A4 Sport

## Specification in addition to SE.

A new offer for A4, the Sport trim builds off the same premium specification as SE with exterior styling upgrades for an enhanced sporty look. Inside, you gain MMI Navigation and an automatic three-month subscription to Audi Connect. Sport seats, a Sport steering wheel and the 180-watt Audi Sound System are also among the additional benefits.

### Wheels

- ▶ 17" '5-spoke Y' design alloy wheels
- ultra TDI models come with low rolling resistance tyres

### Exterior

- ▶ Radiator grille in Twilight grey matt with chrome inlays
- ▶ Air inlets in Titan black with two horizontal inlays in chrome
- ▶ Rear diffuser in Twilight grey matt

### Seats

- ▶ Front Sport seats in System cloth

### Interior equipment

- ▶ 3-spoke leather multi-function Sport steering wheel
- ▶ LED Interior Lighting Pack

### Audio and communication

- ▶ MMI Navigation with 7" colour MMI screen
- ▶ 3D map display
- ▶ MMI search
- ▶ 2 x SDXC card reader
- ▶ Audi Sound System with 10 loudspeakers
- ▶ Audi Connect (3 month trial)

|                           | Petrol         |                |                  |                  | Diesel         |
|---------------------------|----------------|----------------|------------------|------------------|----------------|
| <b>Engine</b>             | 1.4 TFSI       | 2.0 TFSI       | 2.0 TFSI         | 2.0 TFSI quattro | 2.0 TDI ultra  |
| <b>Power</b>              | 150PS          | 190PS          | 190PS            | 252PS            | 150PS          |
| <b>Transmission</b>       | 6-speed manual | 6-speed manual | 7-speed S tronic | 7-speed S tronic | 6-speed manual |
| <b>Saloon</b>             |                |                |                  |                  |                |
| <b>CO<sub>2</sub>g/km</b> | 126*           | 127*           | 116*             | 136*             | 99*            |
| <b>RRP</b>                | £26,165        | £27,965        | £29,495          | £34,715          | £29,415        |
| <b>Recommended OTR</b>    | £26,850        | £28,650        | £30,180          | £35,530          | £30,100        |
| <b>Avant</b>              |                |                |                  |                  |                |
| <b>CO<sub>2</sub>g/km</b> | TBC†           | 129*           | 121*             | 139*             | 104*           |
| <b>RRP</b>                | TBC†           | £29,365        | £30,895          | £36,115          | £30,815        |
| <b>Recommended OTR</b>    | TBC†           | £30,050        | £31,580          | £36,930          | £31,500        |

| Diesel               |                      |                      |                        |                   |                           |
|----------------------|----------------------|----------------------|------------------------|-------------------|---------------------------|
| <b>2.0 TDI ultra</b> | <b>2.0 TDI ultra</b> | <b>2.0 TDI ultra</b> | <b>2.0 TDI quattro</b> | <b>3.0 V6 TDI</b> | <b>3.0 V6 TDI quattro</b> |
| 150PS                | 190PS                | 190PS                | 190PS                  | 218PS             | 218PS                     |
| 7-speed S tronic     | 6-speed manual       | 7-speed S tronic     | 7-speed S tronic       | 7-speed S tronic  | 7-speed S tronic          |
| 101*                 | 102*                 | 103*                 | 114*                   | 109*              | 115*                      |
| £30,945              | £30,315              | £31,845              | £33,275                | £33,565           | £34,995                   |
| £31,630              | £31,000              | £32,530              | £33,960                | £34,250           | £35,680                   |
| 104*                 | 106*                 | 106*                 | 116*                   | 114*              | 119*                      |
| £32,345              | £31,715              | £33,245              | £34,675                | £34,965           | £36,395                   |
| £33,030              | £32,400              | £33,930              | £35,360                | £35,650           | £37,080                   |

\*CO<sub>2</sub> emissions can change if a different size alloy is ordered onto the vehicle. This may lead to a change to the VED amount payable. Please refer to pages 64-65, 114-115, 118-119 and 125. Value based on standard EU test figures for comparative purposes and may not reflect real driving results. †To be announced closer to launch, models arriving April 2016. For more details on the items listed above, please see the Glossary on pages 108-111.

# A4 Sport

Available as Saloon or Avant.



1.



2.



3.



4.

Main image. A4 Avant Sport in optional Scuba blue, metallic (S9). 1. 17" '5-spoke Y' design alloy wheels. 2. Radiator grille in Twilight grey matt with chrome inlays. 3. Air inlets in Titan black with two horizontal inlays in chrome. 4. Rear diffuser in Twilight



5.



6.



7.



8.

Main image. A4 Saloon Sport in optional Scuba blue, metallic (S9). 5. Front Sport seats in System cloth in Black/Red. 6. Inlays in Aluminium Ellipse, silver. 7. 3-spoke leather multi-function Sport steering wheel. 8. MMI® Navigation with 7" colour MMI screen.

# A4 S line

## Specification in addition or replacement to Sport.

Designed with the most driving-focused owners in mind, the top S line specification includes an upgrade to a larger 18" alloy wheel, and visual enhancements courtesy of bespoke S line exterior styling. It further stands out on the road with LED headlights, incorporating LED daytime running lights and LED rear lights with dynamic rear indicators. Sport seats upholstered in a combination of cloth and leather help to set the tone inside, and S line sports suspension does the same for the driving experience.

### Wheels

- ▶ 18" '5-twin-spoke Star' design alloy wheels

### Performance and suspension

- ▶ Sport suspension – lowered by 20mm

### Lighting

- ▶ LED headlights with LED rear lights and dynamic rear indicators
- ▶ Side air inlet grille in Titan black matt with chrome inlays in unique S line design
- ▶ Rear diffuser in Twilight grey matt
- ▶ Rear grille, black grained
- ▶ S line badges on the front wings
- ▶ S line roof edge spoiler (Avant models only)

### Exterior

- ▶ S line front and rear bumpers and side skirts
- ▶ Radiator grille in Twilight grey matt with chrome inlays

|                      | Petrol         |                  |                  | Diesel         |                  |
|----------------------|----------------|------------------|------------------|----------------|------------------|
| Engine               | 2.0 TFSI       | 2.0 TFSI         | 2.0 TFSI quattro | 2.0 TDI        | 2.0 TDI          |
| Power                | 190PS          | 190PS            | 252PS            | 150PS          | 150PS            |
| Transmission         | 6-speed manual | 7-speed S tronic | 7-speed S tronic | 6-speed manual | 7-speed S tronic |
| <b>Saloon</b>        |                |                  |                  |                |                  |
| CO <sub>2</sub> g/km | 130*           | 119*             | 141*             | 106*           | 109*             |
| RRP                  | £29,465        | £30,995          | £36,200          | £30,915        | £32,445          |
| Recommended OTR      | £30,150        | £31,680          | £37,030          | £31,600        | £33,130          |
| <b>Avant</b>         |                |                  |                  |                |                  |
| CO <sub>2</sub> g/km | 132*           | 124*             | 144*             | 111*           | 112*             |
| RRP                  | £30,735        | £32,395          | £37,600          | £32,315        | £33,845          |
| Recommended OTR      | £31,550        | £33,080          | £38,430          | £33,000        | £34,530          |

### Seats

- ▶ Front Sport seats with S embossed logo
- ▶ Sprint cloth/leather
- ▶ 4-way electric lumbar support

### Interior Inlays

- ▶ Inlays in Matt brushed aluminium

### Interior equipment

- ▶ S line 3-spoke leather multi-function Sport steering wheel, grips in perforated leather (and paddles for automatic transmissions)
- ▶ Gear lever knob in black perforated leather
- ▶ Illuminated door sill trims with S logo
- ▶ Pedals and footrest in stainless steel
- ▶ Headlining in black cloth
- ▶ Contrast stitching on seats, steering wheel and gear lever gaiter

| Diesel         |                  |                  |                  |                    |                    |
|----------------|------------------|------------------|------------------|--------------------|--------------------|
| 2.0 TDI        | 2.0 TDI          | 2.0 TDI quattro  | 3.0 V6 TDI       | 3.0 V6 TDI quattro | 3.0 V6 TDI quattro |
| 190PS          | 190PS            | 190PS            | 218PS            | 218PS              | 272PS              |
| 6-speed manual | 7-speed S tronic | 7-speed S tronic | 7-speed S tronic | 7-speed S tronic   | 8-speed tiptronic  |
| 113*           | 111*             | 118*             | 114*             | 119*               | 134*               |
| £31,815        | £33,345          | £34,775          | £35,065          | £36,495            | £38,135            |
| £32,500        | £34,030          | £35,460          | £35,750          | £37,180            | £38,950            |
| TBC*           | 113*             | 120*             | 117*             | 122*               | 139*               |
| TBC*           | £34,745          | £36,175          | £36,465          | £37,895            | £39,535            |
| TBC*           | £35,430          | £36,860          | £37,150          | £38,580            | £40,350            |

\*CO<sub>2</sub> emissions can change if a different size alloy is ordered onto the vehicle. This may lead to a change to the VED amount payable. Please refer to pages 64-65, 114-115, 118-119 and 125. Value based on standard EU test figures for comparative purposes and may not reflect real driving results. \*To be announced closer to launch, models arriving April 2016. For full standard specification, including more details on the items listed above, please see the Glossary on pages 108-111.

# A4 S line

Available as Saloon or Avant.



1.



2.



3.



4.

Main image. A4 Saloon S line in optional Tango red, metallic (Y1). 1. 18" '5-twin-spoke Star' design alloy wheels. 2. LED headlights. 3. Radiator grille in Twilight grey matt with chrome inlays. 4. Rear diffuser in Twilight grey matt.



5.



6.



7.



8.

Main image. A4 Avant S line in optional Tango red, metallic (Y1). 5. Front Sport seats with embossed S logo. 6. Illuminated door sill trims with S logo. 7. S line 3-spoke leather multi-function Sport steering wheel. 8. Inlays in Matt brushed aluminium.

# Paint

Available in a choice of standard and optional colours.

Choose from a selection of 2 standard or 12 optional paint colours. S line models have an additional colour choice of Daytona grey. For more specialist options, Audi exclusive will be available early 2016. Please contact your local Audi Centre for details.

## Standard colours

Available on all models No charge

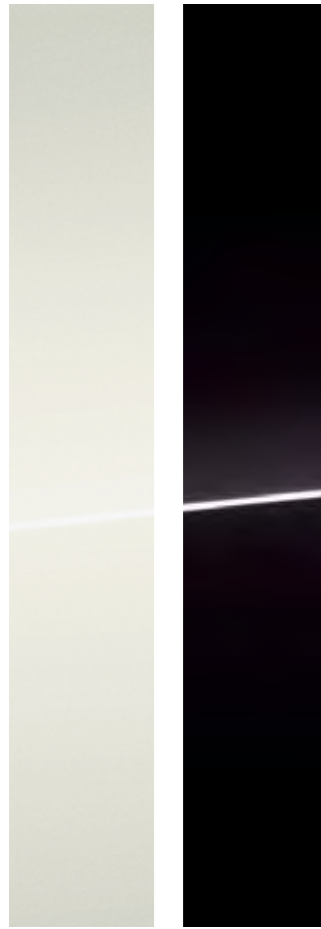

Ibis white, solid, T9

Brilliant black, solid, A2

## Optional colours

Available on all models £645

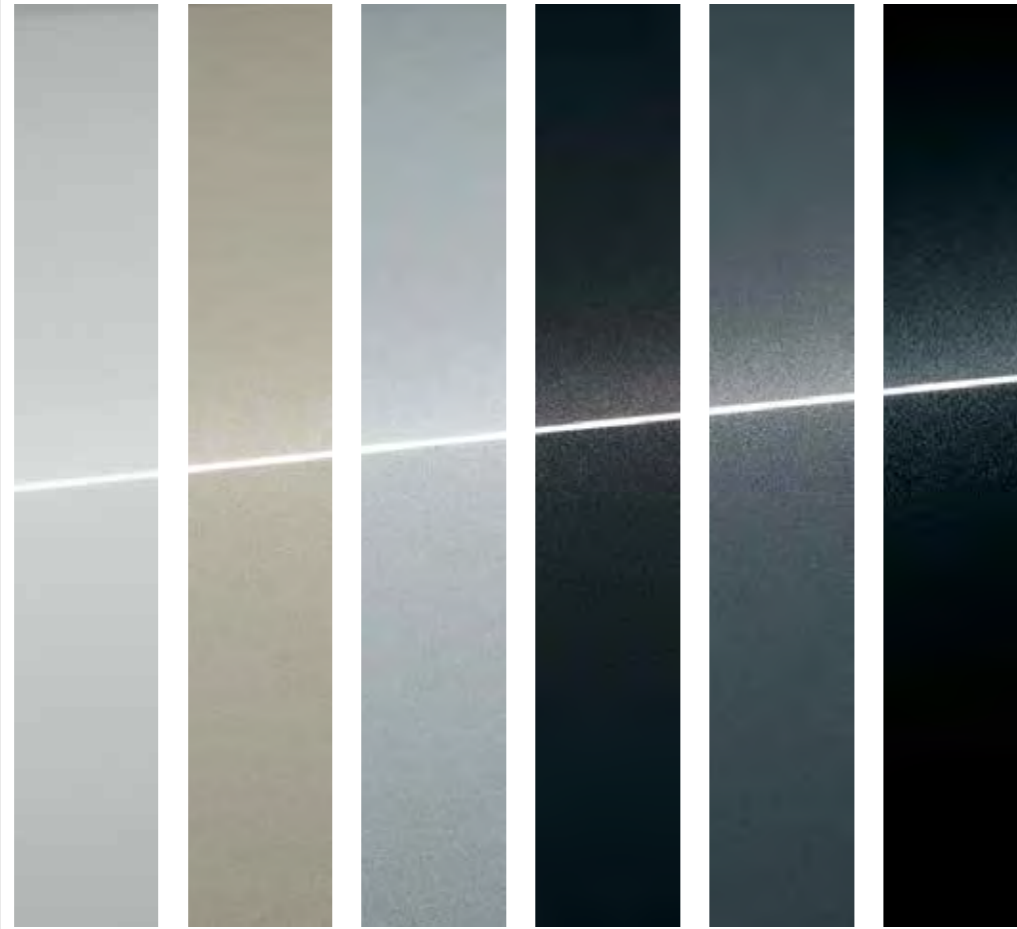

Glacier white, metallic, 2Y

Cuvee silver, metallic, 0D

Floret silver, metallic, L5

Manhattan grey, metallic, H1

Monsoon grey, metallic, 0C

Mythos black, metallic, 0E

## Optional colours

Available on all models £645

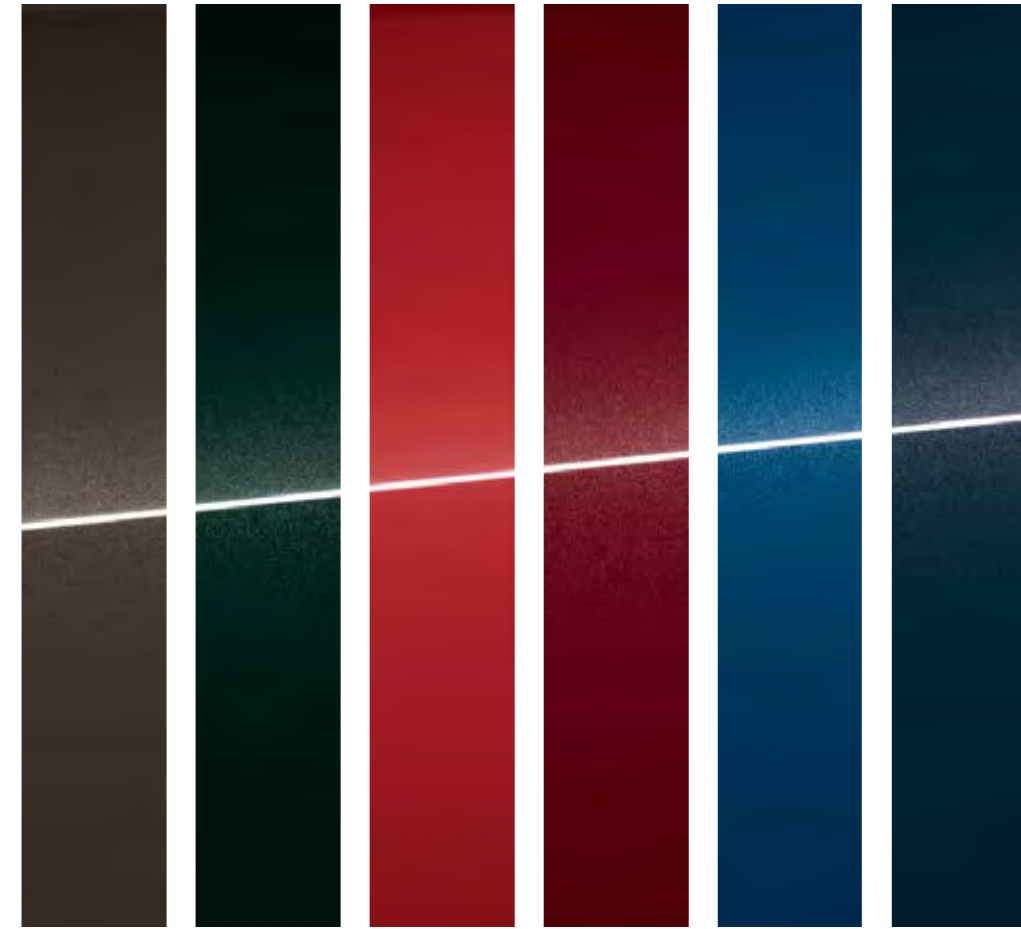

Argus brown, metallic, W3

Gotland green, metallic, Q6

Tango red, metallic, Y1

Matador red, metallic, T7

Scuba blue, metallic, S9

Moonlight blue, metallic, W1

## S line colour

Available on S line models only £645



Daytona grey, Pearl effect, 6Y



Audi exclusive available soon.



# Wheels

## Enhance your style.

Whatever your taste, there's a set of alloy wheels that will add the final flourish to your A4.

### Tyre information

All 17" wheels supplied with:  
17" x 7.5J 225/50 R17 tyres.

All ultra TDI models are only available with 17" alloy wheels and come with low rolling resistance tyres.

All 18" wheels supplied with:  
18" x 8.0J 245/40 R18 tyres.

All 19" wheels supplied with:  
19" x 8.5J 245/35 R19 tyres.

All pricing is RRP including VAT. Options are subject to availability and may extend delivery.

Please note that the size of your chosen A4 wheel may affect the fuel consumption figures and the CO<sub>2</sub> emissions. This may result in a change in subsequent Vehicle Excise Duty payable. Please see pages 114-115, 118-119 and 125 for details.

### 17" alloy wheels



17" '10-spoke crystal' design alloy wheels

|     |    |          |
|-----|----|----------|
| C8F | SE | Standard |
|-----|----|----------|



17" '5-spoke Y' design alloy wheels

|     |       |          |
|-----|-------|----------|
| C4N | Sport | Standard |
|-----|-------|----------|



17" '5-arm tornado' design alloy wheels

|     |       |      |
|-----|-------|------|
| PRF | SE    | £250 |
|     | Sport | £250 |



17" '5-arm star' design alloy wheels

|     |       |      |
|-----|-------|------|
| PRE | SE    | £250 |
|     | Sport | £250 |



17" '5-parallel spoke' design alloy wheels

|     |       |      |
|-----|-------|------|
| PRH | SE    | £250 |
|     | Sport | £250 |

### 18" alloy wheels



18" '10-spoke V' design alloy wheels

|     |       |      |
|-----|-------|------|
| PRD | SE    | £850 |
|     | Sport | £850 |



18" '5-twin-spoke' design alloy wheels, diamond cut finish

|     |       |      |
|-----|-------|------|
| PRJ | SE    | £850 |
|     | Sport | £850 |



18" '5-twin-spoke' design alloy wheels

|     |       |        |
|-----|-------|--------|
| PQG | Sport | £1,200 |
|-----|-------|--------|



18" '5-twin-spoke star' design alloy wheels

|     |        |          |
|-----|--------|----------|
| PRB | S line | Standard |
|-----|--------|----------|



18" '5-spoke dynamic' design alloy wheels, diamond cut finish

|     |        |           |
|-----|--------|-----------|
| PRA | S line | No charge |
|-----|--------|-----------|

### 19" alloy wheels



19" '10-V spoke' design alloy wheels

|     |        |      |
|-----|--------|------|
| PQ5 | S line | £900 |
|-----|--------|------|



19" '5-V spoke' design alloy wheels in matt titanium look, diamond cut finish

|     |        |       |
|-----|--------|-------|
| PQI | S line | £1200 |
|-----|--------|-------|

# Performance and suspension

## Options for ultimate handling, comfort and agility.

### Comfort Dynamic suspension

Newly developed suspension system with increased comfort and agility whilst retaining sport driving characteristics.

### Sport suspension

Lowered by 20mm compared to Comfort Dynamic suspension, with stiffer suspension and damping for more direct contact with the road and sportier handling.

### Dynamic steering

Enhances driving dynamics and ride comfort by regulating the steering according to the driving situation. With this technology, driving is significantly more agile under everyday conditions, while directional stability and precision are increased at high speeds and in demanding driving situations.

### Adaptive Comfort suspension with damping control

Electronically regulated suspension system which offers maximum ride comfort. Suspension is lowered by 10mm and adjusts to different driving situations. Dynamic or comfort-orientated characteristics for shock absorber settings adjusted via Audi Drive Select.

### Adaptive Sport suspension with damping control

Electronically regulated suspension system which offers the ultimate sport ride. Suspension is lowered by 20mm (as per Sport suspension) and adjusts to different driving situations. Provides sportier response with improved comfort. Dynamic or comfort-orientated characteristics for shock absorber settings adjusted via Audi Drive Select.

|     |  | SE            | Sport    | S line    |
|-----|--|---------------|----------|-----------|
| 1BA | <b>Comfort Dynamic suspension</b> Not available on TDI ultra models                          | Standard      | Standard | No charge |
| 1BE | <b>Sport suspension</b> Standard on all TDI ultra models                                     | Not available | £325     | Standard  |
| 1N8 | <b>Dynamic steering</b>  | £950          | £950     | £950      |
| 1BL | <b>Adaptive Comfort suspension with damping control</b><br>Not available on TDI ultra models | £900          | £900     | £600      |
| 1BQ | <b>Adaptive Sport suspension with damping control</b>  | £900          | £900     | £600      |



Image shows A4 S line with standard 18" '5-twin-spoke star' design alloy wheels with Sport suspension (1BE)



1.



2.



3.



4.

1. Matrix LED headlights with LED rear lights and dynamic front and rear indicators (PXC). 2. Dynamic rear indicators (PXC or PX2). 3. Headlight washers (8X1). 4. LED headlights with LED rear lights and dynamic rear indicators (PX2).

# Lighting

Advanced headlights that adapt to the road.

## Matrix LED headlights with LED rear lights & dynamic front and rear indicators

Audi Matrix LED technology provides maximum and precise illumination at all times without dazzling other road users. Using information obtained from the vehicle's sensors, camera and MMI Navigation (if equipped), Matrix Beam calculates the appropriate lighting required and automatically dips or turns off individual lighting diodes creating corridors of lights either side of the vehicle or object in front. Includes dynamic front and rear indicators which sweep from inside to out within 0.15 seconds. This helps to clearly identify not only that the vehicle is turning, but in which direction – increasing road safety.

## LED headlights with LED rear lights & dynamic rear indicators

All-weather headlights with dynamic headlight adjustment and dipped beam, high beam, indicators and turning light in LED technology. Enables a near daylight illumination of the road, minimum energy consumption and long service life. Includes dynamic rear indicators which sweep from inside to out within 0.15 seconds. This helps to clearly identify not only that the vehicle is turning, but in which direction.

## High-beam assist

Detects the headlights of oncoming traffic, the rear lights of other road users and light sources in built-up areas. Depending on the traffic situation, the high beam automatically adjusts to dipped beam and vice versa. The system improves the driver's visibility and ensures a more relaxed drive thanks to the extra comfort and convenience.

|     |   | SE    | Sport | S line   |
|-----|---|-------|-------|----------|
| PXC | <b>Matrix LED headlights with LED rear lights &amp; dynamic front and rear indicators</b> Also available in Light and Vision Pack (WB7, 9S8)                      | £1750 | £1750 | £650     |
| PX2 | <b>LED headlights with LED rear lights &amp; dynamic rear indicators</b>  | £1050 | £1050 | Standard |
| 8G1 | <b>High-beam assist</b> Also available in Vision Pack (WB6, 9S8). Not available in conjunction with Matrix LED headlights (PXC) or Light & Vision Pack (WB7, 9S8) | £150  | £150  | £150     |
| 8X1 | <b>Headlight washers for excellent illumination and improved visibility</b>   | £250  | £250  | £250     |

# Exterior equipment

Innovative options for added style and convenience.

## Black Styling Pack

Includes radiator grille frame, radar sensor surrounds in the side grilles (if fitted), trim strips on the side windows and B-pillar trims in high-gloss black. Radiator grille, front side grilles and front license plate holder in matt black. Also includes door mirror housings in gloss black (6FJ) and on Avant models, black roof rails (352).

## Door mirrors (folding)

Electrically folding, adjustable and heated with built-in LED side indicators and kerb view function for passenger side.

## Door mirrors (folding with memory function)

Electrically folding with memory function. Electrically adjustable and heated with built-in LED side indicators and kerb view function for passenger side.

## Door mirrors (folding with auto-dimming and memory function)

Auto-dimming with memory function, electrically folding, adjustable and heated with built-in LED side indicators and kerb view function for passenger side.

|          |   | SE            | Sport     | S line    |
|----------|---|---------------|-----------|-----------|
| 4ZD, 6FJ | <b>Black Styling Pack</b>   | Not available | £550      | £550      |
| 6XE      | <b>Door mirrors (folding)</b>   | £225          | £225      | £225      |
| 6XF      | <b>Door mirrors (folding with memory function)</b> Only available in combination with electrically adjustable front seats (PV3 or PS8)  | £225          | £225      | £225      |
| 6XL      | <b>Door mirrors (folding with auto-dimming and memory function)</b> Only available in combination with electrically adjustable front seats (PV3 or PS8)   | £325          | £325      | £325      |
| OM1      | <b>Fuel tank 54 litres</b> Available as an option on all 2.0 TDI models, to increase fuel tank from 40 to 54 litres. All 3.0 TDI and TFSI engines come as standard with 54 litre tank and quattro variants with 58 litre tank | No charge     | No charge | No charge |
| FK2      | <b>Ad Blue tank 24 litres</b> Available as an option on all 2.0 TDI models, to increase AdBlue® tank from 12 to 24 litres. Standard on all 3.0 TDI models. Not applicable to TFSI engines                                     | No charge     | No charge | No charge |



Image shows A4 Avant S line with optional Audi exclusive Sprint blue, pearl effect paint, Black Styling Pack (4ZD, 6FJ) 19" '10-V spoke' alloy wheels (PQ5) and Driver Assistance Pack – Tour (PCN).

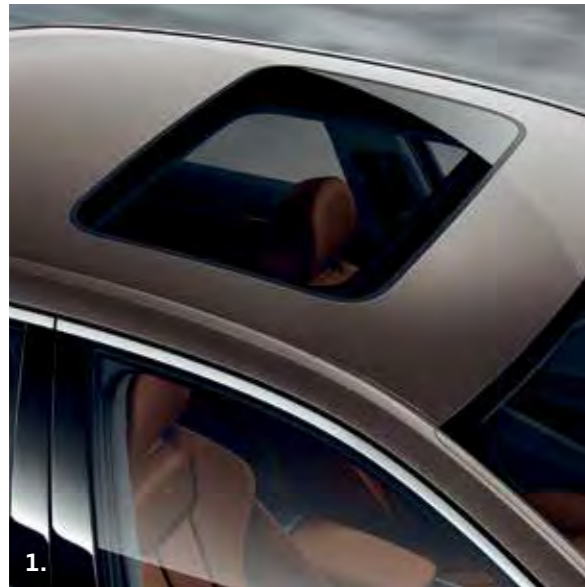

1.



2.



3.



4.

1. Electric slide and tilt sunroof (3FE). 2. Panoramic glass sunroof (3FU). 3. Privacy glass and front acoustic glazing (VW6). 4. Tow bar, folding (1D4).

# Exterior equipment

## Innovative options for added style and convenience.

### Electric slide and tilt sunroof

Available on Saloon models, it comprises of a single glass section, which raises and opens electrically. Includes a manually adjustable sunshield and convenience closing via the central locking remote control.

### Panoramic glass sunroof

Available on Avant models, it comprises of two tinted glass sections. The front glass section raises and opens electrically. Includes an electrically adjustable sunshield and convenience closing via the central locking remote control.

### Privacy glass and front acoustic glazing

Dark-tinted rear and rear-side windows (from B-pillar backwards) and front side windows in acoustic glass for better exterior noise insulation.

### Heated windscreen\*

Facilitates rapid defrosting and provides a condensation-free windscreen. Controlled via a button on the air conditioning controls; additionally the windscreen can reflect the sun's heat preventing the interior from heating up.

### Tow bar (folding)

Mechanically swivelling ball head with electric release. Operated via a button in the luggage compartment. Includes trailer/caravan stabilisation via Electronic Stability Control (ESC) and allows continual use of electrical devices in the trailer/caravan whilst driving. 13- to 7-pin adaptor may be required please consult your Audi Centre for details.

### Garage door opener (Homelink®)\*\*

Programmable radio-operated remote control buttons incorporated in the interior lighting module. Can be used for opening and/or closing garage doors and exterior gates. Control of security and Lighting systems is also possible.\*\*\*

|     |   | SE        | Sport     | S line    |
|-----|---|-----------|-----------|-----------|
| 3FE | <b>Electric slide and tilt sunroof</b> Only available on Saloon models            | £950      | £950      | £950      |
| 3FU | <b>Panoramic glass sunroof</b> Only available on Avant models                     | £1250     | £1250     | £1250     |
| VW6 | <b>Privacy glass and front acoustic glazing</b>                                   | £450      | £450      | £450      |
| 4GR | <b>Heated windscreen*</b> Only available in combination with Audi Phone Box (9ZE) | £400      | £400      | £400      |
| 1D4 | <b>Tow bar - Manual swivel</b>  | £850      | £850      | £850      |
| VC1 | <b>Garage door opener (Homelink®)**</b>   | £250      | £250      | £250      |
| 2Z0 | <b>Deletion of model and technology designation at rear</b>                       | No charge | No charge | No charge |
| 2Z7 | <b>Deletion of engine technology designation at rear</b>                          | No charge | No charge | No charge |

All pricing is RRP including VAT. Options are subject to availability and may extend delivery. \*Available early 2016. \*\*Homelink® is a registered trademark of Johnston Controls. \*\*\*For information on compatible hand transmitters, please contact your Audi Centre or [www.eurohomelink.com](http://www.eurohomelink.com)

# A4 SE seat colours and trim

## Standard seats

### Concept cloth (N1N) – standard on SE No charge

Although referred to as standard, there really is nothing ordinary or standard about this seat. Comfortable, stylish and available in a choice of Black or Rock grey Concept cloth. Seat functionality includes manual adjustment for seat forwards/backwards position, backrest angle, head restraint, seat belt height. Concept cloth in the following areas: seat upholstery, head restraints, front centre armrest and door trim inserts.

### Twin leather (N1F) – optional on SE £850

A new combination trim offering the comfort and style of leather but without the higher cost. For maximum durability, real leather is applied in the following areas: seat centre panels on the front seats, driver's seat bolster (entrance side only) and seat centre panels on the two outer rear seats. Leatherette trim is applied on the head restraints, seat side bolsters, door trim inserts, centre armrest and middle rear seat. Available in a choice of four leather colours as shown on page 75.

### Milano leather (N5W) – optional on SE £1350

High quality and long lasting leather with a fine grain appearance. Milano leather is in the following areas: entire seat including head restraints and centre armrest. Door trim inserts are in leatherette. Available in a choice of four leather colours as shown on page 75.



**Concept cloth**  
N1N Standard on SE  
No charge



| Upholstery              | Black - YM    | Rock grey - ZG         |
|-------------------------|---------------|------------------------|
| Headlining              | Titanium grey | Titanium grey          |
| Dashboard (upper/lower) | Black/Black   | Granite grey/Rock grey |
| Carpet                  | Black         | Granite grey           |

Image shows a Standard seat with optional 4-way electric lumbar support (7P1). All colour swatches on this page are matched as accurately as possible to the actual upholstery colours used. However, due to print processes, Audi UK cannot guarantee that the colours shown are 100% accurate. Visit your local Audi Centre for a more accurate colour swatch.

# A4 SE optional colours and trim

## Standard seats with optional upholstery finishes.

Upgrade the upholstery on your standard seat by choosing either Twin leather or Milano leather. Both available in a choice of four colours with Rock grey and Atlas beige additionally available with a two tone dashboard.

**Twin leather**  
N1F Optional on SE  
£850

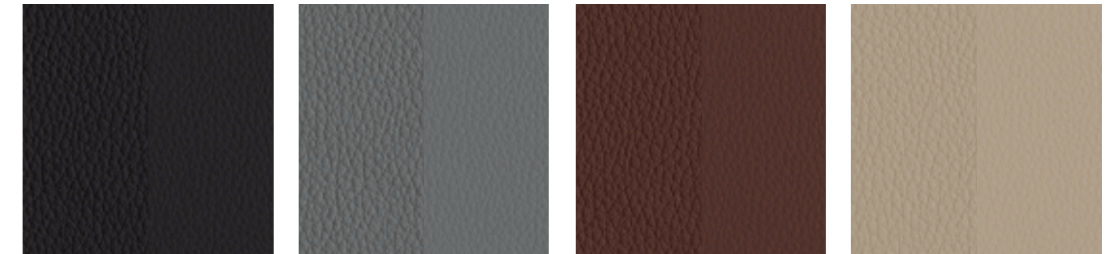

**Milano leather**  
N5W Optional on SE  
£1350

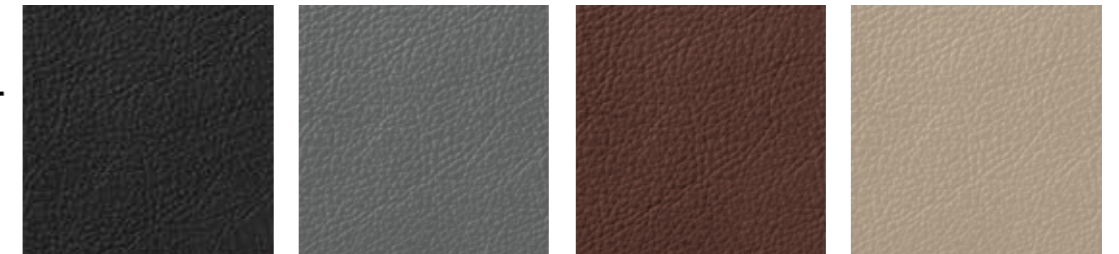

| Upholstery              | Black - YM    | Rock grey - ZF | Nougat brown - ZK | Atlas beige - ZE |
|-------------------------|---------------|----------------|-------------------|------------------|
| Headlining              | Titanium grey | Titanium grey  | Titanium grey     | Titanium grey    |
| Dashboard (upper/lower) | Black/Black   | Black/Black    | Black/Black       | Black/Black      |
| Carpet                  | Black         | Black          | Black             | Black            |

| Upholstery              | Rock grey - ZG         | Atlas beige - ZI         |
|-------------------------|------------------------|--------------------------|
| Headlining              | Titanium grey          | Atlas beige              |
| Dashboard (upper/lower) | Granite grey/Rock grey | Granite grey/Atlas beige |
| Carpet                  | Granite grey           | Granite grey             |

All pricing is RRP including VAT. Options are subject to availability and may extend delivery.



Image shows A4 Sport with Sport seat in System cloth in Black/Red (AH)

# A4 Sport Seat colours and trim

## Sport seats

### System cloth (N2E) – standard on Sport No charge

The interior of the new A4 Sport trim has the styling credentials to compliment the exterior. The seats not only have a sport design but also with their extended thigh support and prominent side bolsters they offer a firmer, more supported driving style due to improved lateral support. Available as standard in a choice of full black or black/red System cloth. Seat functionality includes manual adjustment for seat height, seat forwards/backwards position, backrest angle, head restraint and seat belt height. System cloth in the following areas: seat upholstery, thigh supports, head restraints, front centre armrest and door trim inserts.

### Twin leather (N1F) – optional on Sport £850

A new combination trim offering the comfort and style of leather but without the higher cost. For details on Twin leather and where it is applied please see page 74. Available in a choice of three leather colours as shown on page 78.

### Leather/Alcantara (N7U) – optional on Sport £1150

The addition of Alcantara upholstery with leather enhances the styling on your seats, offers additional grip for sportier driving and at the same time offers added comfort across the seasons. Seat centre, shoulder panels and door trim inserts in Alcantara. Seat side bolsters, head restraints and front centre armrests in leather complete the look. Available in a choice of two leather colours as shown on page 78.

### Milano leather (N5W) – optional on Sport £1350

High quality and long lasting leather with fine grained appearance. For details on Milano leather and where it is applied please see page 74. Available in a choice of four leather colours as shown on page 78.

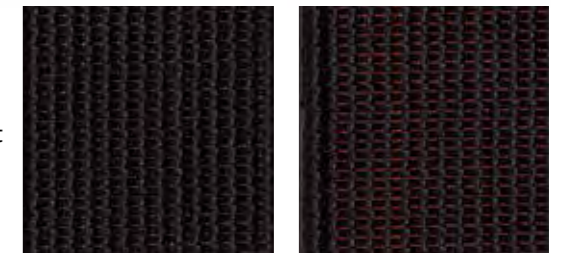

**System cloth**  
N2E Standard on Sport  
No charge

| Upholstery              | Black – YM    | Black/Red – AH |
|-------------------------|---------------|----------------|
| Headlining              | Titanium grey | Titanium grey  |
| Dashboard (upper/lower) | Black/Black   | Black/Black    |
| Carpet                  | Black         | Black          |

Image shows a Sport seat with Climate function (PS8) and with optional Electrical adjustment (3L5) and 4-way electric lumbar support (7P1). For an image of a Standard Front Sport seat see page 76. All pricing is RRP including VAT. Options are subject to availability and may extend delivery.

# A4 Sport optional colours and trim

Sport seats with optional upholstery finishes.

**Twin leather**  
N1F **Optional on Sport**  
£850

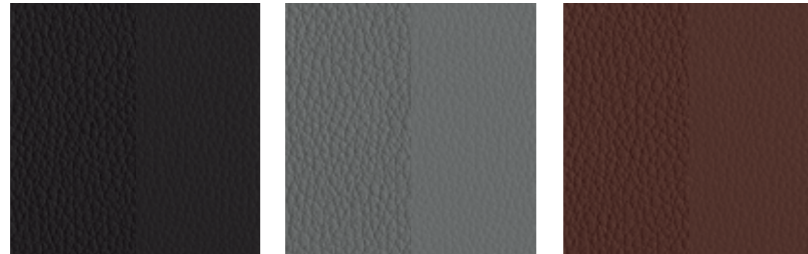

**Leather/  
Alcantara**  
N7U **Optional on Sport**  
£1150

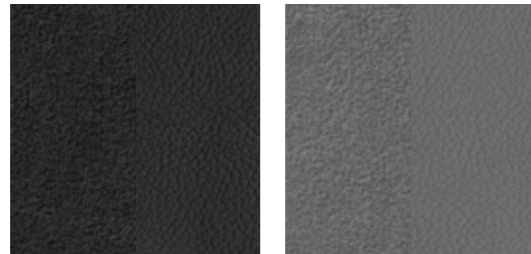

**Milano leather**  
N5W **Optional on Sport**  
£1350

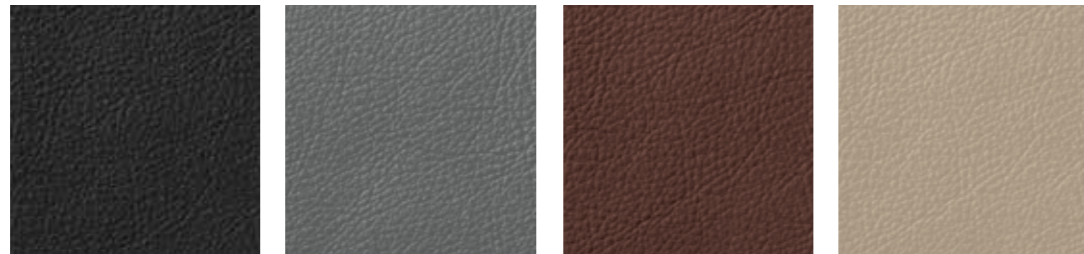

| Upholstery              | Black – YM             | Rock grey – ZF* | Nougat brown – ZK        | Atlas beige – ZE |
|-------------------------|------------------------|-----------------|--------------------------|------------------|
| Headlining              | Titanium grey          | Titanium grey   | Titanium grey            | Titanium grey    |
| Dashboard (upper/lower) | Black/Black            | Black/Black     | Black/Black              | Black/Black      |
| Carpet                  | Black                  | Black           | Black                    | Black            |
| Upholstery              | Rock grey – ZG         |                 | Atlas beige – ZI         |                  |
| Headlining              | Titanium grey          |                 | Atlas beige              |                  |
| Dashboard (upper/lower) | Granite grey/Rock grey |                 | Granite grey/Atlas beige |                  |
| Carpet                  | Granite grey           |                 | Granite grey             |                  |

\*Not available on Leather/Alcantara.  
All colour swatches on this page are matched as accurately as possible to the actual upholstery colours used. However, due to print processes, Audi UK cannot guarantee that the colours shown are 100% accurate. Visit your local Audi Centre for a more accurate colour swatch.

# A4 Sport optional colours and trim

Climate function for Front Sport seats PS8

**Optional on Sport**

To maximise seat comfort in hot weather, the climate function option provides active ventilation for the seat and backrest centre sections of the driver and front passenger seats. Three different cooling intensities are available and operated via the climate control panel. Includes the added functionality of electric 4-way lumbar support (7P1). To allow for the ventilation the seat centre panels are perforated. The outer rear seats are also perforated to match, but are not ventilated.

Only in combination with Twin Leather (N1F) or Milano Leather (N5W) and with the following chargeable options: Heated seats (4A3 or 4A4) and Electrically adjustable front seats (3L5 or PV3). Please note these seats have a unique design compared to standard Front Sport seats see page 77.

**Climate  
function with  
Twin leather**  
N1F **Optional on SE**  
£1600

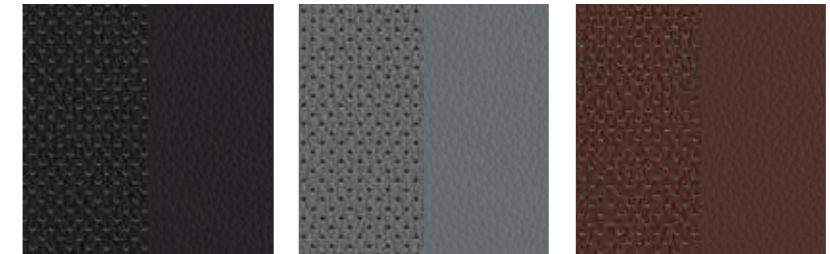

**Climate  
function with  
Milano leather**  
N5W **Optional on Sport**  
£2100



| Upholstery              | Black – YM             | Rock grey – ZF | Nougat brown – ZK |
|-------------------------|------------------------|----------------|-------------------|
| Headlining              | Titanium grey          | Titanium grey  | Titanium grey     |
| Dashboard (upper/lower) | Black/Black            | Black/Black    | Black/Black       |
| Carpet                  | Black                  | Black          | Black             |
| Upholstery              | Rock grey – ZG         |                |                   |
| Headlining              | Titanium grey          |                |                   |
| Dashboard (upper/lower) | Granite grey/Rock grey |                |                   |
| Carpet                  | Granite grey           |                |                   |





Image shows A4 S line with optional Fine Nappa leather (N3M) and Light and Vision Pack (WB7, 9S8).

# A4 S line colours and trim

## Front Sport seats with S embossed logo

### Sprint cloth/Leather (N7V) – standard on S line No charge

Unique to the S line, standard Front Sport seats with Sprint cloth/leather upholstery come with ‘S’ embossing on the front seat backs and the added functionality of electric 4-way lumbar support. The seats not only have a sporty design but also offer a firmer and more supported driving style with extended thigh support and prominent side bolsters which improve lateral support.

Seat functionality includes manual adjustment for seat height, seat forwards/backwards position, backrest angle, head restraint and seat belt height. Seat centre, shoulder panels and door trim inserts in cloth. Seat side bolsters, head restraints and front centre armrest in leather. Enhanced with contrast stitching in the following areas:

seats, steering wheel, gear lever, armrest and floor mats.

### Leather/Alcantara (N7K) – optional on S line £450

Unique to S line, Alcantara with an embossed pattern and contrast stitching enhances the styling of your seats, offers additional grip for sportier driving and at the same time provides added comfort across the seasons. Seat centre, shoulder panels and door inserts in patterned Alcantara. Seat side bolsters, head restraint and front centre armrest in leather.

### Fine Nappa leather (N3M) – optional on S line £1250

Upgrade S line seats to the highest quality, supple Fine Nappa leather which is breathable, durable and features a natural fine grain. Seat upholstery, head restraints, and front centre armrest in Fine Nappa leather. Door trim inserts in Alcantara.

### Sprint cloth/Leather

N7V Standard on S line  
No charge

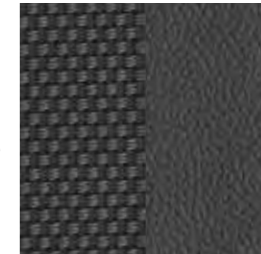

### Leather/Alcantara

N7K Optional on S line  
£450

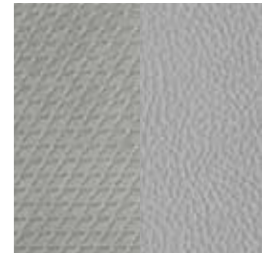

### Fine Nappa leather

N3M Optional on S line  
£1250

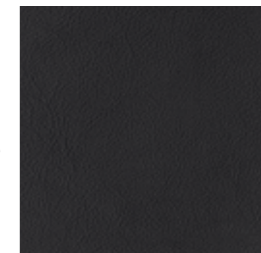

| Upholstery              | Black – EI  | Rotor grey – 0Q |
|-------------------------|-------------|-----------------|
| Headlining              | Black       | Black           |
| Dashboard (upper/lower) | Black/Black | Black/Black     |
| Carpet                  | Black       | Black           |

All pricing is RRP including VAT. Options are subject to availability and may extend delivery.

# A4 Seat options

## Further options to enhance your seats.

### 4-way electric lumbar support

For front seats with horizontal and vertical adjustment to further increase seat comfort.

### Electrically adjustable front seats

Electric adjustment for seat height, seat forwards/backwards position, seat angle and backrest angle.

### Electrically adjustable front seats with memory function for the driver's side

Electric adjustment of both front seats with memory function for the driver's side. Includes the following: Electric adjustment for seat height, seat forwards/backwards position; seat angle and backrest angle; Electric 4-way lumbar support; Two memory spaces for the electrically adjustable driver's seat and exterior mirrors.

### Heated front seats

Heating for seat and backrest centre panels. When in combination with Sport seats and leather upholstery, the side bolsters are also heated. Individually adjustable in several stages for driver and front-passenger side via the air-conditioning controls.

### Heated front and outer rear seats

Works in the same way as front seat heating, enabling you to regulate the outer rear seats separately.

|     |   | SE   | Sport | S line   |
|-----|---|------|-------|----------|
| 7P1 | <b>4-way electric lumbar support</b><br>Also available in Comfort and Sound Pack (WB3)  | £250 | £250  | Standard |
| 3L5 | <b>Electrically adjustable front seats</b><br>Also available in Comfort and Sound Pack (WB3)  | £700 | £700  | £700     |
| PV3 | <b>Electrically adjustable front seats with memory function for the driver's side</b> Only in combination with Exterior mirrors with memory function (6XF or 6XL) | £950 | £950  | £800     |
| 4A3 | <b>Heated front seats</b>   | £300 | £300  | £300     |
| 4A4 | <b>Heated front and outer rear seats</b><br>Not available in combination with cloth seats   | £575 | £575  | £575     |



Image shows A4 Sport with optional Leather/Alcantara upholstery (N7U) in Rock grey (ZG)

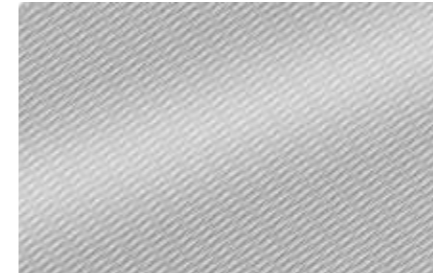

Image shows optional Oak, natural grey inlays (7TL), Audi Virtual Cockpit (958) and Technology Pack (WB4).

# Interior inlays

Fine detailing that enhances the interior of your A4.

Inlays for instrument panel, door trims and centre console:



Aluminium Ellipse, silver

|     | SE            | Standard      |
|-----|---------------|---------------|
| 5TT | <b>Sport</b>  | Standard      |
|     | <b>S line</b> | Not available |



Matt brushed aluminium

|     | SE            | Not available |
|-----|---------------|---------------|
| 5TG | <b>Sport</b>  | Not available |
|     | <b>S line</b> | Standard      |



Oak, natural grey

|     | SE            | £200          |
|-----|---------------|---------------|
| 7TL | <b>Sport</b>  | £200          |
|     | <b>S line</b> | Not available |



Walnut, dark brown

|     | SE            | £200          |
|-----|---------------|---------------|
| 5MG | <b>Sport</b>  | £200          |
|     | <b>S line</b> | Not available |



Piano finish, Black

|     | SE            | £200      |
|-----|---------------|-----------|
| 5TL | <b>Sport</b>  | £200      |
|     | <b>S line</b> | No charge |

All the inlay swatches on this page are matched as accurately as possible to the actual inlay colours used. However, due to print processes, Audi UK cannot guarantee that colours shown are 100% accurate. Visit your local Audi Centre for a more accurate colour swatch. Options are subject to availability and may extend delivery.

# Interior equipment

Options to enhance the interior of your A4.

## Extended LED Interior Lighting Pack – multi-coloured

In addition to the LED Interior Lighting Pack (QQ1) listed below, coloured ambient lighting in the following areas ▶ Door trims, front and rear ▶ Door storage areas, front and rear ▶ Cup holder ▶ Centre console ▶ Footwells, front and rear. Three pre-defined colour profiles are available which can be individually selected or interactively set with your Audi Drive Select mode.

## LED Interior Lighting Pack

In addition to the standard interior lighting: Illuminated vanity mirrors ▶ Ambient lighting in the front and rear door trims and interior door handles ▶ Courtesy lighting on the exterior door handles for easy entry and exit in the dark ▶ Entry lights, front and rear ▶ Illuminated cup holder ▶ Ambient lighting in the centre console; Lighting for both front and rear footwells.

## Extended Interior Upholstery Pack

Lower part of the centre console, door armrests and door pull handles in leatherette matching interior colour choice. Only available in combination with Leather/Alcantara, Milano leather or Fine Nappa leather. Contrast stitching further enhances the interior elements when Fine Nappa leather is ordered.

## Heated 3-spoke leather trimmed high multi-function steering wheel

Control of on-board computer, telephone, radio and navigation system with both hands on the steering wheel. Includes paddles for automatic transmissions. Colour to match the selected dashboard upper section. Steering wheel design is dependant on trim choice.\*

## Flat bottomed 3-spoke leather trimmed high multi-function steering wheel

Control of on-board computer, telephone, radio and navigation system with both hands on the steering wheel. Includes paddles for automatic transmissions. Colour to match the selected dashboard upper section. When ordered on SE trim, the design of the steering wheel changes to the Sport trim design.

|     |   | SE   | Sport    | S line   |
|-----|---|------|----------|----------|
| QQ2 | <b>Extended LED Interior Lighting Pack – multi-coloured</b><br>Also available in Light and Vision Pack (WB7, 9S8) | £325 | £100     | £100     |
| QQ1 | <b>LED Interior Lighting Pack</b>   | £225 | Standard | Standard |
| 7HB | <b>Extended Interior Upholstery Pack</b>  | £250 | £250     | £250     |
| 1XP | <b>Heated 3-spoke leather trimmed high multi-function steering wheel</b>  | £300 | £300     | £300     |
| 2PF | <b>Flat bottomed 3-spoke leather trimmed high multi-function steering wheel</b>                                   | £225 | £225     | £225     |
| 6NQ | <b>Black cloth headlining</b>   | £250 | £250     | Standard |

All pricing is RRP including VAT. Options are subject to availability and may extend delivery.

\*Refer to trim pages for steering wheel designs.



1. Extended LED interior lighting pack multi-coloured (QQ2). 2. Flat-bottomed 3-spoke leather trimmed high multi-function steering wheel (2PF).

# Interior equipment

## Practical options for advanced storage and stowage.

### Storage Pack

Includes the following items in the car: Storage net on the back of the front seat backrests ▶ Storage compartment driver's side ▶ Lockable glove box ▶ Rear centre armrest. Includes the following in the luggage compartment ▶ Tensioning straps, left and right (Avant) ▶ Bag hook (Saloon) ▶ 12V socket ▶ Luggage nets.

### Rails system with load-securing kit

Flexible system for securing objects in the A4 Avant luggage compartment. A telescopic bar and securing strap enable the luggage compartment to be divided diagonally and/or horizontally. 4 x sliding lashing points on the rail provide additional fastening options. After use, the kit can be stowed away in the loading floor.

### Variable foldable trunk mat

Increase the everyday usability of the A4 Avant luggage area, with a reversible, flexible rubber mat. The entire load area even with folded rear seat backrest, can be covered to protect against dirt or damage. Or, if the trunk mat is installed horizontally, the side panel trims of the luggage compartment can be covered. Or, the mat can be used flexibly to divide the luggage area into individual compartments. Thanks to its compact design, the trunk mat can be stowed away to the side of the luggage compartment.

### Rear side airbags

For the outer rear seats, incorporated into the seat backrests; supplements the standard airbag systems.

### Variable head restraints for front seats

With manual adjustment of headrest height, tilt and distance.

|     |   | SE   | Sport | S line |
|-----|---|------|-------|--------|
| QE1 | <b>Storage Pack</b>   | £175 | £175  | £175   |
| 3GN | <b>Rails system with load-securing kit</b> Only available on Avant models | £200 | £200  | £200   |
| 6SJ | <b>Variable foldable trunk mat</b> Only available on Avant models         | £125 | £125  | £125   |
| 4X4 | <b>Rear side airbags</b>  | £350 | £350  | £350   |
| 3Y4 | <b>Roll up blinds for rear door windows</b>                               | £150 | £150  | £150   |
| 9JD | <b>Smoking pack</b> Includes cigarette lighter and ash trays              | £50  | £50   | £50    |
| 5ZC | <b>Variable head restraints for front seats</b>                           | £125 | £125  | £125   |



1.



2.

1. Rails system with load-securing kit (3GN). 2. Variable foldable trunk mat (6SJ).

# Technology Packs

## Technology Pack <sup>WB4</sup>

This pack brings together the most popular technology options that are frequently ordered together and offers exceptional customer value versus the price of the individual items. This pack is essential for those wanting the highest level of connectivity and navigation system.

**MMI Navigation Plus with MMI touch.** In addition to standard MMI Radio Plus\*, includes the following:

- ▶ 8.3" high resolution, colour MMI display with aluminium frame
- ▶ Touch-sensitive control panel for fast, intuitive operation, handwriting recognition, and ability to move and zoom freely on the map
- ▶ Integrated navigation with 3D map display of places of interest
- ▶ Online map updates
- ▶ Detailed route information: map preview, choice of alternative routes, POIs, lane recommendations, motorway exits, detailed junction maps and more
- ▶ Dynamic route guidance traffic updates with TMCpro (in conjunction with Audi Connect: traffic information online)
- ▶ MMI search: Free text search with intelligent suggestions provided during entry
- ▶ Natural voice recognition
- ▶ Jukebox hard drive memory for music (10 GB)
- ▶ DVD drive for music CDs and video DVDs
- ▶ 2xSDXC memory card reader.



MMI Navigation Plus

## Driver Information System - 7" colour display

High-resolution TFT 7" full colour display in the instrument cluster offering an even better overview and readability of information compared to the standard 5-inch display. Displays additional information from the standard DIS such as navigation map and driver assistance systems. See page 109 for standard display information.

## High multi-function 3-spoke leather trimmed steering wheel

Includes paddles for automatic transmission. Control of onboard computer, telephone, radio and navigation system with both hands on the steering wheel. Refer to trim pages for steering wheel designs.



MMI touch



High multi-function 3-spoke leather trimmed steering wheel on S line model\*\*



Audi Phone Box with wireless charging

**Audi Connect (3-year subscription)** Convenient connection of your vehicle to the internet via an integrated data module with LTE/UMTS connection. Highlights of Audi Connect services include navigation with Google Earth™ and Google Street View™, destination input via myAudi or Google Maps™, access to Google and Twitter, Wi-Fi hotspot, weather and news online and travel information. A separate data SIM card can be inserted in the SIM card reader. See pages 42-45 and 125 for more information.

**Audi Phone Box with wireless charging** Offers improved reception quality and wireless charging (with Qi enabled compatible phones). For more information, see full option description of Audi Phone Box on page 99. Audi Phone Box option also provides an additional bluetooth interface for a second device meaning two mobile phones can be connected to the vehicle simultaneously.

|     |                        | SE    | Sport | S line |
|-----|------------------------|-------|-------|--------|
| WB4 | <b>Technology Pack</b> | £2000 | £1450 | £1450  |

# Technology Packs

## Comfort and Sound Pack WB3

A pack that adds value, by combining some of our most popular options designed to offer convenience as well as enhancing your driving comfort, sound experience and pleasure.

**Electrically adjustable front seats** Electric adjustment for seat height, seat forwards backwards position, seat angle and backrest angle

**4-way electric lumbar support** For front seats with horizontal and vertical adjustment.

**Convenience key** Access and authorisation system that works through automatic data exchange between key and vehicle, allowing the driver to keep their car key in their pocket or bag at all times. Vehicle locked and unlocked from outside via sensors on the door handles. Pressing the Start/Stop button integrated in the centre console starts and stops the engine.

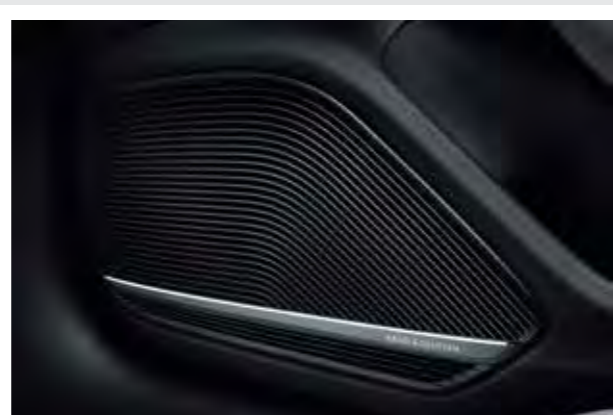

Bang & Olufsen 3D sound system

**Bang & Olufsen 3D sound system** The system features 19 loudspeakers including a subwoofer and centre loudspeaker and a 16 channel amplifier with an output of 755 watts. Spatial sound reproduction through the new 3D sound feature for the front seats. Includes speed sensitive volume adjustment and illuminated loudspeakers within the front doors.



Electrically adjustable front seats

|     |                               | SE    | Sport | S line |
|-----|-------------------------------|-------|-------|--------|
| WB3 | <b>Comfort and Sound Pack</b> | £1775 | £1500 | £1250  |

## Vision Pack WB6, 9S8

Keeps your focus on the road, with features that put driver information in your line of vision - and enhances your A4's headlights, so they won't dazzle other drivers. As with all the new A4 technology packs, you can expect a high level of customer value.

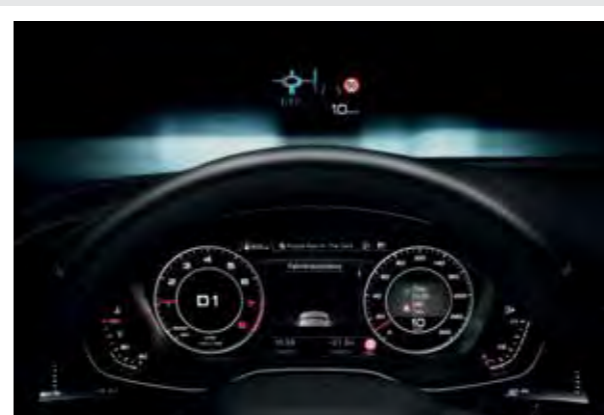

Audi Virtual Cockpit and Head up display

**Audi Virtual Cockpit** Innovative 12.3" full colour digital instrument cluster for the flexible display of information tailored to the driver's needs. Displays the following:  
 ▶ Vehicle/engine speed ▶ 3D Navigation map ▶ Audi Connect services ▶ Radio/media information ▶ Driver assistance systems ▶ All MMI functionalities (e.g. Telephone, Car settings etc). The 'view' button on the multi-function steering wheel allows you to change between 2 differently sized representations of the instrument dials. The display with small instruments allows the onboard computer and MMI contents to be shown on across the full display area.

**Head-up display** Projects warning messages or driving related information from assistance systems and navigation system (if ordered) in full colour onto the windscreen in the driver's direct field of vision, giving the driver faster access to information. Display is adjustable in height.

**High beam assist** Detects the headlights of oncoming traffic, the rear lights of other road users and light sources in built-up areas. Depending on the traffic situation, the high beam automatically adjusts to dipped beam and vice versa. The system thereby improves the driver's visibility and ensures a more relaxed drive thanks to the extra comfort and convenience.



High beam assist

|          |   | SE    | Sport | S line |
|----------|---|-------|-------|--------|
| WB6, 9S8 | <b>Vision Pack</b> Only available in combination with Technology Pack (WB4) | £1150 | £1150 | £1150  |

All pricing is RRP including VAT. Options are subject to availability and may extend delivery.

# Technology Packs

## Light & Vision Pack WB7, 9S8

See more, both inside and outside your A4 with our most advanced lighting technology and the ultimate driver information system, Audi Virtual Cockpit. Available for S line models only, this pack combines the most innovative options with great value.

**Audi Virtual Cockpit** Innovative 12.3" full colour digital instrument cluster for the flexible display of information tailored to the driver's needs. Displays the following:

- ▶ Vehicle/engine speed
- ▶ 3D Navigation map
- ▶ Audi Connect services
- ▶ Radio/media information
- ▶ Driver assistance systems
- ▶ All MMI functionalities (e.g. Telephone, Car settings etc). The 'view' button on the multi-function steering wheel allows you to change between two differently sized representations of the instrument dials. The display with small instruments allows the onboard computer and MMI contents to be shown on across the full display area.



Audi Virtual Cockpit

## Extended LED Interior Lighting Pack - multi-coloured

In addition to the LED Interior Lighting Pack (QQ1) includes coloured ambient lighting in the following areas:

- ▶ Door trims, front and rear
- ▶ Door storage areas, front and rear
- ▶ Cup holder
- ▶ Centre console
- ▶ Footwells, front and rear. Three predefined colour profiles are available which can be individually selected, or interactively set with your Audi Drive Select mode.



Extended LED Interior Lighting Pack - multi-coloured



Matrix LED headlights with LED rear lights and dynamic front and rear indicators

## Matrix LED headlights with LED rear lights and dynamic front and rear indicators

Audi Matrix technology provides maximum and precise illumination at all times without dazzling other road users. The vehicle uses information obtained from multiple sources including sensors, a camera and the MMI Navigation system (if ordered) to identify the appropriate lighting required. Using these sources, Matrix beam dips or fully extinguishes individual lighting diodes when vehicles are detected ahead. Matrix beam is capable of establishing and tracking multiple road users and illuminating the appropriate corridors

of lights either side of them, to maintain maximum visibility of the road and surrounding environment, without causing disruption to other drivers. Matrix beam technology includes dynamic front and rear indicators which sweep from inside to out within 0.15 seconds. This helps to clearly identify not only that the vehicle is turning, but in which direction – increasing road safety as it is easier for other road users to determine which way cars are moving in a shorter amount of time.

|          |  | SE            | Sport         | S line |
|----------|--|---------------|---------------|--------|
| WB7, 9S8 | <b>Light &amp; Vision Pack.</b> Only available in combination with Technology Pack (WB4) | Not available | Not available | £975   |



# Technology - Audio & communication

Your options for music and entertainment.

## Bang & Olufsen 3D sound system

The ultimate premium sound experience in your A4 with concert hall acoustics and for the first time, with 3D stereo surround sound. The system features 19 loudspeakers, including a subwoofer and centre loudspeaker and a 16-channel amplifier with an impressive total output of 755 watts. The natural 3D surround sound is created with additional speakers in the A-pillar, which now create a new height dimension in sound in addition to depth and width. This creates a previously unknown feeling of space in the car. Includes speed sensitive volume adjustment and illuminated loudspeakers within the front doors.

## Audi sound system

Impressive sound with 10 loudspeakers including centre speaker and subwoofer, 6-channel amplifier with a total output of 180 watts.

## Digital TV reception

Reception of digital (DVB-T) uncoded television stations (MPEG-2 standard), TV picture, teletext and Electronic Programme Guide (EPG). Facility to connect two external AV sources via adaptor cables (available from Audi Genuine Accessories). Please note: TV reception depends on local digital network availability. Picture display only possible on MMI screen when your Audi A4 is stationary, audio available at all times.

## Audi Entertainment Mobile

Includes two detachable high definition 10.1" touch screens fitted to the back of the front seats (supplied by Audi Genuine Accessories\*). The back of the front seats are fitted with mountings and power connections. The system can be used outside the car with rechargeable battery, which is included in the package. Content is either streamed from your iOS (iPhone) or Android (Samsung, HTC, Sony etc) smartphone via an Audi App, via an integrated SD card reader, USB cable, Miracast Wi-Fi or Bluetooth. Includes two sets of headphones, USB cable and storage bag.

|     |   | SE    | Sport    | S line   |
|-----|---|-------|----------|----------|
| 9VS | <b>Bang &amp; Olufsen 3D sound system</b><br>Also available in Comfort and Sound Pack (WB3)   | £975  | £750     | £750     |
| 9VD | <b>Audi sound system</b>  | £275  | Standard | Standard |
| QU1 | <b>Digital TV reception</b> Only available with Technology pack (WB4)   | £1100 | £1100    | £1100    |
| 9WQ | <b>Audi Entertainment Mobile*</b><br>Only available in combination with Electrically adjustable front seats (3L5) and 4-way electric lumbar support (7P1) | £1325 | £1325    | £1325    |



1. Bang & Olufsen 3D sound system (9VS). 2. Audi Entertainment Mobile (9WQ).

# Technology - Audio & communication

Your options for infotainment and connectivity.

## Audi Virtual Cockpit

Innovative 12.3-inch full colour digital instrument cluster for the flexible display of information tailored to the driver's needs. Displays the following: ▶ Vehicle/engine speed ▶ 3D Navigation map ▶ Audi Connect services ▶ Radio/media information ▶ Driver assistance systems ▶ All MMI functionalities (e.g. Telephone, Car settings etc). The 'view' button on the multi-function steering wheel allows you to change between two differently sized representations of the instrument dials. The display with small instruments allows the onboard computer and MMI contents to be shown across the full display area.

## MMI Navigation (SD card based)

In addition to standard MMI Radio Plus, includes the following:

- ▶ Integrated navigation with 3D map display
- ▶ Detailed route information: map preview, choice of alternative routes, POIs, lane recommendations, motorway exits, detailed junction maps and more
- ▶ Dynamic route guidance with TMCpro (in conjunction with Audi Connect: traffic information online)
- ▶ MMI search: Free text search with intelligent suggestions provided during entry
- ▶ Natural voice recognition
- ▶ 2xSDXC memory card reader

For details on MMI Radio Plus please refer to the Glossary on page 110

## Audi Phone Box with wireless charging

Enables drivers to use their mobile phone in the car by placing it in the storage compartment provided in the front centre console to create a wireless connection to the vehicle aerial, improving reception quality. Operated via the MMI control panel, the multi-function steering wheel or the voice control system. Wireless charging available (with Qi enabled compatible phones) or via USB port. For information on compatible mobile phones please see audi.co.uk. Audi Phone Box option also provides an additional Bluetooth interface for a second device meaning two mobile phones can be connected to the vehicle simultaneously.



1.



2.



3.

1. Audi Virtual Cockpit (9S8). 2. MMI Navigation (SD card based) (PNU). 3. Audi Phone Box with wireless charging (9ZE).

|     |  | SE   | Sport    | S line   |
|-----|--|------|----------|----------|
| 9S8 | <b>Audi Virtual Cockpit .</b><br>Also available in Vision Pack (WB6, 9S8) and Light and Vision Pack (WB7, 9S8). Only available in combination with Technology Pack (WB4) | £450 | £450     | £450     |
| PNU | <b>MMI Navigation (SD card based)</b>  | £550 | Standard | Standard |
| 9ZE | <b>Audi Phone Box with wireless charging.</b><br>Also available in Technology Pack (WB4)   | £325 | £325     | £325     |

# Technology - Driver assistance

## Driver Assistance Pack - Tour PCN

With busier roads than ever, Audi technology can keep an extra eye out. This pack brings together the driver assistance systems that support long distance driving, especially when driving in congestion and varying average speed limit zones. As well as helping you to drive more efficiently, the pack also includes advanced safety systems.

**Pre-sense front** - Extends the collision warning and automatic braking function of pre-sense city to cover the entire speed range and can also increase braking initiated by the driver if this is inadequate. The system uses the camera located on the front rear-view mirror to detect vehicles and pedestrians in front in order to reduce severity of a collision, or if possible prevent an accident. The driver is first given a visual and acoustic warning followed by partial braking and then full brake application.

**Camera based traffic sign recognition** - Speed limit and traffic sign display via the Driver's Information System (DIS) or optional Head-up display. Detects the following signs: speed limits (including temporary limits), overtaking restrictions and no-entry warnings.



Camera based traffic sign recognition\*\*

**Collision avoidance assistant** - Supports the driver's actions during an avoidance manoeuvre reducing the likelihood of a collision or of swerving off the road. The system provides additional steering torque and uses vehicle sensors to calculate the optimum path of avoidance.

**Turn Assist** - When turning at junctions, from the moment the turn indicators are activated, the turn assist system detects approaching vehicles and applies braking to help avoid a collision.

**Active Lane Assist** - Detects lane boundary markings and helps the driver to stay in lane with gentle steering intervention for greater safety and convenience, particularly on motorways. Works at speeds above 37mph.

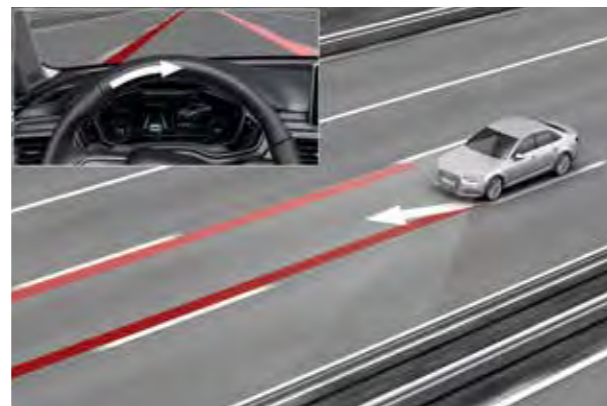

Active Lane Assist\*\*



Adaptive Cruise Control with Stop & Go and Traffic jam assist\*\*



Predictive efficiency assistant\*\*

**Adaptive Cruise Control with Stop & Go and Traffic jam assist** - Automatic distance regulation, using radar sensors to maintain the required distance between vehicles ahead by braking and accelerating. With the Stop & Go function, the system brakes the car to a stop. The driver can select from 5 warning thresholds and influence the systems acceleration behaviour via Audi Drive Select. Traffic jam assist detects vehicles ahead and on adjacent lanes to assist with the braking, acceleration and also steering up to 37mph, to keep the vehicle in lane. Adaptive cruise requires additional sensors in the lower air inlets, and results in a change to the design of the inlets and differs dependant on trim. The images above show the design for SE and Sport (left) and S line (right).

**Predictive efficiency assistant** - The system uses navigation data e.g. speed limits, traffic signs, road bends, junctions and roundabouts to give the driver efficiency advice in the instrument cluster (or via the optional Audi Virtual Cockpit). In conjunction with the Adaptive Cruise Control (ACC), the system uses the route data and speed limits to adjust the ACC desired speed and cornering accordingly. With automatic transmissions, the system activates free-wheeling mode or engine braking, which can help reduce fuel consumption up to 10% and enhances ride comfort.

\*Vehicle driver assistance and safety systems are not a substitute for attentive driving. Drivers retain full responsibility for providing the necessary inputs for safe control of the vehicle. System descriptions within this brochure are provided for information purposes only. System limitations and operational requirements apply. See manual for details.

\*\*Images show display on optional Audi Virtual Cockpit, which can be ordered as part of the Vision Pack, Light and Vision Pack or as an individual option. Display will appear on the 7" colour DIS without this option.

|     |   | SE    | Sport | S line |
|-----|---|-------|-------|--------|
| PCN | <b>Driver Assistance Pack - Tour</b> Only available in combination with Technology Pack (WB4), High-beam assist (8G1) and Parking system plus (7X2) | £1250 | £1250 | £1250  |

All pricing is RRP including VAT. Options are subject to availability and may extend delivery.

# Technology - Driver assistance

## Parking Assistance Pack PCF

Enhancing the rear parking sensors that come as standard, this pack adds front sensors and all-round cameras to optimise your view while parking - and can even help you find and manoeuvre into a parking space.



360° camera showing birds eye view

**360° cameras** - Wide angle lenses cover the close range around the vehicle. The driver can choose between different image representations in the MMI display, including a live “bird’s eye view” image for parking. Includes guidelines which help the driver manoeuvre and navigate the vehicle into the right position.

**Parking assist** - Searches for suitable parking spaces along the road by means of ultrasonic sensors, calculates the ideal parking path and performs the steering action virtually automatically. Steering is done by the vehicle; the driver need only accelerate and apply the brakes.

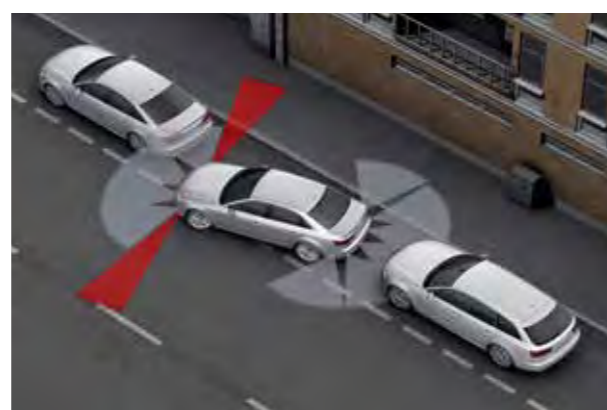

Parking assist

|     |   | SE    | Sport | S line |
|-----|---|-------|-------|--------|
| PCF | <b>Parking Assistance Pack.</b><br>Only available with optional mirrors (6XE, 6XF, 6XL) and Technology Pack (WB4) | £1250 | £1250 | £1250  |

## Parking Assistance Pack Advanced PCZ

In addition to the contents of the Parking Assistance Pack, this pack includes the latest technology to provide help in busy traffic situations, when changing lane, exiting your car and when reversing - for the convenience and protection of all occupants.



Cross Traffic Assist Rear

**Audi Pre-sense Basic** - Audi pre-sense is a comprehensive technical package for identifying dangers well in advance and intervening appropriately to provide extra safety and protection. Where necessary, actions are taken to protect the driver and passengers from a potential collision. These include: belt tightening, activating the hazard warning system, closing the windows and the sunroof (if fitted).

**Audi Pre-sense Rear** - It monitors vehicles following from behind and if a potential collision is detected, the driver is first warned visually via flashing light, then Audi Pre-sense basic measures (e.g. closing windows) are initiated and then if a collision is unavoidable, the system will tighten the front seat belts. The system is deactivated when towing.

**Audi Side Assist** - Aids the driver when changing lane. Audi side assist monitors the area behind the vehicle, using radar sensors located discreetly in the rear bumper, informing the driver with a visual warning signal in the door mirror if there is a vehicle in their blind spot or approaching quickly from behind.

**Cross Traffic Assist Rear** - Warns the driver of traffic crossing behind their own vehicle when reversing. The system alerts the driver first visually and then acoustically via the MMI, and then applies the brakes if a potential collision is detected.

**Exit Warning** - Monitors the rear and side of your stationary A4 and warns the occupants via a warning light on the door before they exit that vehicles/cyclists are approaching from behind.



Exit warning

|     |  | SE    | Sport | S line |
|-----|--|-------|-------|--------|
| PCZ | <b>Parking Assistance Pack Advanced.</b><br>Only available with optional mirrors (6XE, 6XF, 6XL) and Technology Pack (WB4) | £1675 | £1675 | £1675  |

Vehicle driver assistance and safety systems are not a substitute for attentive driving. Drivers retain full responsibility for providing the necessary inputs for safe control of the vehicle. System descriptions within this brochure are provided for information purposes only. System limitations and operational requirements apply. See manual for details.

# Technology - Driver assistance

Advanced options to help you on and off the road.

## Head-up display

Projects warning messages or driving-related information from assistance systems and the navigation system (if ordered) in full colour onto the windscreen in the driver's direct field of vision, giving the driver faster access to information. Display is adjustable in height.

## Camera-based traffic sign recognition

Speed limit and traffic sign display via the Driver's Information System (DIS) or optional Head-up display. Detects the following signs: speed limits (including temporary limits), overtaking restrictions and no-entry warnings.

## Parking system plus

Acoustic and visual park assist system for the front and rear with MMI screen display showing the calculated path (steer-angle dependent) including guidelines. Measurement is by ultrasonic sensors concealed in the bumpers.

## Rearview camera

An image of the area behind the vehicle is shown on the MMI display. Reversing camera is concealed in the handle strip of the luggage compartment lid.

## Advanced key with electric hands-free boot opening system

Access and authorisation system that works through automatic data exchange between key and vehicle, allowing the driver to keep their car key in their pocket or bag at all times. To unlock and open, simply lift the exterior door handle. Pressing the Start/Stop button integrated in the centre console starts and stops the engine. Also includes an electric hands-free bootlid release sensor located underneath the rear bumper, which can be operated by a simple kicking movement underneath the sensor.

|         |   | SE   | Sport | S line |
|---------|---|------|-------|--------|
| KS1     | <b>Head-up display.</b> Also available in Vision Pack (WB6, 9S8)                                | £900 | £900  | £900   |
| QR9     | <b>Camera-based traffic sign recognition.</b><br>Only in combination with Technology Pack (WB4) | £275 | £275  | £275   |
| 7X2     | <b>Parking system plus</b>  | £395 | £395  | £395   |
| KA2     | <b>Rear view camera.</b><br>Only available in combination with Parking system plus (7X2)        | £450 | £450  | £450   |
| PGD/PGB | <b>Advanced key with electric hands-free boot opening system.</b><br>Saloon (PGD), Avant (PGB)  | £525 | £525  | £525   |
| UH2     | <b>Hill hold assist</b>   | £75  | £75   | £75    |



1. Head-up display (KS1). 2. Rear view camera (KA2). 3. Camera based traffic sign recognition (QR9). 4. Advanced key, with electric hands-free boot opening system (PGD or PGB).

# Audi Genuine Accessories

## Personalise your Audi today.

Make your Audi A4 your own by adding some genuine accessories. All created by Audi and specially crafted for our models, so they'll deliver the high standards you'd expect. What you see here is just a selection. See the full collection at [audi.co.uk/accessories](http://audi.co.uk/accessories)



### Rubber/Textile floor mats

Protect the A4 interior from muddy feet and daily wear and tear.



### Boot liner

Avoid damage while loading and unloading luggage.



### Roof bars

Transport larger items, from bikes to snowboards.



### Roof box

Add to the A4's already generous luggage capacity.



### Audi entertainment mobile

Keep rear seat passengers entertained with the double screen package.



### Laptop bag

Keep everything organised while you travel.

# Audi warranty

## Protection against the unexpected.

All new Audi models now come with a choice of three, four or five-year warranty.\* What's more, if you decide to sell your Audi before the warranty expires, it will be fully transferred to the new owner. So, whichever length of warranty you choose, you can forget about unexpected repair bills and enjoy several years of carefree driving.

|     |   | SE       | Sport    | S line   |
|-----|---|----------|----------|----------|
| -   | <b>Audi Warranty</b> , covering you for unlimited mileage in the first two years of ownership, and up to 60,000 miles in the third year. Transferable between owners**  | Standard | Standard | Standard |
| EA6 | <b>Audi Warranty</b> , covering you for up to 4 years or 75,000 miles, whichever comes sooner. Cover includes a two-year unlimited mileage warranty, and up to 75,000 miles in the third and fourth years. Transferable between owners**        | £385     | £385     | £385     |
| EA9 | <b>Audi Warranty</b> , covering you for up to 5 years or 90,000 miles, whichever comes sooner. Cover includes a two-year unlimited mileage warranty, and up to 90,000 miles in the third, fourth and fifth years. Transferable between owners** | £905     | £905     | £905     |

\*Three-year warranty consists of a two-year unlimited mileage warranty and a third year warranty with a 60,000-mile limitation. Four-year warranty consists of a two-year unlimited mileage warranty and two further years' coverage with a 75,000-mile limitation. Five-year warranty consists of a two-year unlimited mileage warranty and three further years' coverage with a 90,000-mile limitation. \*\*Only available before registration of your Audi A4. Please speak to your Audi Centre for full details.

# Audi glossary

## Your guide to A4 standard equipment.

### AdBlue®

All Audi A4 TDI models are fitted with AdBlue® technology. The AdBlue® solution is stored in a tank positioned near the car's conventional fuel tank, accessed through a screw-cap usually found next to the car's fuel filler nozzle. The AdBlue® tank may require a top-up between services.

### Audi Connect, 3 month trial

Free use of Audi Connect services for a period of 3 months. See page 42-45 & 125 for more information on Audi Connect services. Only available with MMI Navigation. Wi-Fi hotspot will continue after the 3 month period providing there is a valid Data SIM.

### Audi Drive Select

Changes your car's handling and response at the touch of a button to suit the way you want to drive. Enables the driver to alter the throttle response, gear-shift characteristics and steering feel between five pre-set modes: Comfort, Auto, Dynamic, Efficiency and in conjunction with an MMI navigation system, Individual.

The Efficiency mode sets the engine, automatic transmission, air conditioning and cruise control systems to a more fuel efficient basic setting helping to save fuel and reduce emissions. Efficiency mode is not available on 1.4 TFSI engines.

### Automatic Start-Stop with coasting functionality

Helps to reduce fuel consumption and CO<sub>2</sub> emissions by switching off the engine when the vehicle is stationary, and also when slowing down e.g. on approach to traffic lights. To restart the engine, the starting procedure is initiated as soon as the clutch is depressed or the foot brake is released. It can be deactivated at any time via a button.

### Bluetooth interface (1 device)

Bluetooth-compatible mobile phones can be connected to the vehicle via the interface, allowing handsfree calls via the microphone. Also includes Bluetooth audio streaming (dependent on mobile phone capability).

### Comfort Dynamic suspension

Outstanding handling characteristics and excellent driving comfort with light weight five-link front suspension, tubular anti-roll bar and trapezoidal-link rear suspension with independent suspension. See page 66

### Cruise control system with speed limiter

At speeds above approximately 19mph, cruise control maintains the set desired speed. The speed limiter allows a maximum speed to be set which can not be exceeded even by increasing the pressure on the accelerator pedal helping the driver to keep to the speed limit. The driver can temporarily disable or deactivate the speed limiter at any time by kick down (pressing on the accelerator pedal past the point of resistance). Also includes free-wheeling capability, which significantly reduces fuel consumption and CO<sub>2</sub> emissions through intelligent use of free-wheeling phases when cruise control is active. This is available in the Audi Drive Select Efficiency mode and only in combination with automatic transmissions.

### Deluxe 3-zone electronic climate control

Design-led and intuitive operation via a large TFT display which features touch sensitive rocker switches and integrated digital temperature displays in the rotary push buttons. Electronically regulates air temperature, air flow rate and air distribution. Exact temperature can be set individually for driver, front passenger and rear seats. The rear air conditioning can be operated from the front and additional control panel in the rear. Eco button activates efficiency-optimised air conditioning. The newly developed air conditioning blower is more efficient, quieter and lighter. The system automatically selects the climate control mode for optimum comfort and maximum efficiency. Class-leading high air quality inside the vehicle thanks to the combination filter with activated charcoal, air quality sensor and automatic air recirculation control.

### Drivers Information System – 5" monochrome display

Standard on all models with MMI Radio Plus and MMI Navigation. 5-inch TFT monochrome display in the instrument cluster. Displays a variety of information; ▶ Time ▶ Odometer ▶ Outside temperature ▶ Fuel level warning with remaining range ▶ Gear change recommendation (for manual transmission and automatic transmission in manual mode) ▶ Telephone menu ▶ Current radio station or music title, radio and media lists.

The on-board computer with short-term and long-term memory supplies information about the average and momentary fuel consumption, remaining range, average speed, driving time and distance travelled.

The integrated efficiency program supports the driver with overviews of fuel consumption data, a larger gear-change indicator (for manual transmission) and economy tips for more economical driving. Also includes rest recommendation.

### Efficiency programme

Supports the driver with overviews of fuel consumption data, gear-change indicator (for manual transmission) and tips for more economical driving. Displayed in the Drivers Information System. Includes attention assist.

### Electric boot lid release – Saloon models only

The luggage compartment lid opens automatically when the luggage compartment is unlocked with the remote control key, the button in the driver's door or by pushing the soft-touch release on the lid.

### Electric load area cover – Avant models only

Electric, rail-mounted cover for the luggage compartment. Moves up automatically, uncovering the load area as soon as the tailgate is opened (with both manual and electric opening). When the tailgate is closed, the load area cover moves down again to cover the load area. The load area cover can still be retracted manually.

### Electromechanical parking brake

Includes parking brake function when stationary, drive-off assistance function through automatic release when driving away and emergency braking function whilst driving, acting on all 4 wheels.

# Audi glossary

## Exhaust system

Three different tailpipe versions differentiate models visually according to their engine for both Saloon and Avant.

Single-branch design with one tailpipe on the left:  
1.4 TFSI and 2.0 TDI 150PS

Single-branch design with two tailpipes on the left:  
2.0 TDI 190PS and 3.0 TDI

Dual-branch design with one tailpipe each on the left and right: 2.0 TFSI

Chrome-plated exhaust trims are standard on every A4

## Interior lighting

Includes the following:

- ▶ Passive door warning lights
- ▶ Front and rear roof module lights
- ▶ Glove compartment light (with bulb)
- ▶ Tailgate lighting (Avant only)
- ▶ Luggage compartment lighting

## Keyless go

Conveniently allows the engine to be started by simply pressing the Start/Stop button in the centre console allowing the driver to keep the key in their pocket or bag.

## MMI® Radio Plus with Smartphone Interface and MMI controller

Includes the following:

- ▶ 7" colour MMI display with black frame
- ▶ MMI controller with integrated joystick function
- ▶ Audi Smartphone Interface - Connects your smartphone with your A4 bringing your mobile content seamlessly via USB directly into the MMI display. Navigation, telephone, music and selected third-party apps can be easily controlled via the MMI controller and via voice control system. See page 38-41 for more information
- ▶ Voice recognition and control - a short press on the voice control button activates Audi voice control and a long press activates your smartphone voice assistant
- ▶ 2 USB charging ports and 1 AUX-IN located in the centre console
- ▶ CD drive
- ▶ 1 SDCX card reader
- ▶ AM / FM / DAB radio
- ▶ 8 passive loudspeakers (4 front and 4 rear)
- ▶ Ready for Nav – preparation that enables MMI Radio Plus to be upgraded to MMI Navigation as a retro-fit at your local Audi Centre

## Multi-collision brake assist

Once a primary collision has happened, Multi-collision brake assist supports to avoid additional accidents if possible. The system automatically initiates a full braking application to reduce the risk of skidding and further collisions in an accident. The reduction in speed also makes the vehicle easier to control after impact.

## Pop-up bonnet

Active hinges raise the bonnet if pedestrian contact is sensed.

## Power operated tailgate – Avant models only

The luggage compartment lid opens automatically when the luggage compartment is unlocked with the remote control key, the button in the driver's door or by pushing the soft-touch release on the lid. In conjunction with optional convenience key or Advanced key, opening/closing is also possible from the key.

## Pre-sense City

The system uses the camera located on the front rear-view mirror to detect vehicles and pedestrians in front. If an imminent collision is detected, the system warns the driver. Subject to certain system limits, up to speeds of approximately 52mph, the system may initiate emergency braking application and if possible prevent the collision. Vehicle driver assistance and safety systems are not a substitute for attentive driving. Drivers retain full responsibility for providing the necessary inputs for safe control of the vehicle. System descriptions within this brochure are provided for information purposes only. System limitations and operational requirements apply. See manual for details.

## Rear parking sensors

Facilitates parking by acoustically indicating the distance to obstacles; measurement is by ultrasonic sensors integrated discreetly into the bumper.

## S tronic® 7-speed transmission

The new S tronic transmission with completely revised driveline has remarkable gear shift performance, sporty set up yet at the same time is still efficient. Now available for the first time with front wheel drive. S tronic can be manually operated using the shift paddles behind the steering wheel or via the selector lever. In automatic mode, programmes D (Drive) and S (Sport) can be selected.

## Tiptronic 8-speed transmission

For engines with torque higher than 400 Nm, Tiptronic enhances the quattro experience with improved traction and driving dynamics. Whether you want to drive efficiently or sporty, the gear-shifts between the eight speeds are achieved without any interruption in propulsive power.

## Tow bar preparation

Includes wiring. The set of parts for retrofitting are available from Audi Genuine Accessories or as an option (1D4). Please contact an Audi Centre for more details.

## Tyre pressure warning light

Visual and acoustic warning if the pressure drops in one or more tyre.

## Xenon headlights with LED daytime running lights

The Xenon high-beam headlights underline the progressive character of the all-new Audi A4.

All-weather headlights with dynamic headlight adjustment. Dipped beam and high beam in Xenon technology with LED day time running lights.



# A4 Saloon technical data

## Key information about your car.

All of our A4 engines meet EU6 emissions standards. For Diesel engines, this means the addition of an AdBlue® tank to ensure compliance. The AdBlue® tank size for your engine is shown below and it may require a top-up between services.

|  | Petrol         |                |                  |                  | Diesel         |                  |                |
|--|----------------|----------------|------------------|------------------|----------------|------------------|----------------|
| Engine   | 1.4 TFSI       | 2.0 TFSI       | 2.0 TFSI         | 2.0 TFSI quattro | 2.0 TDI ultra* | 2.0 TDI ultra*   | 2.0 TDI        |
| Transmission                                       | 6-speed manual | 6-speed manual | 7-speed S tronic | 7-speed S tronic | 6-speed manual | 7-speed S tronic | 6-speed manual |
| Cylinder   | 4-cylinder     | 4-cylinder     | 4-cylinder       | 4-cylinder       | 4-cylinder     | 4-cylinder       | 4-cylinder     |
| Displacement, cubic cm (valves per cylinder)       | 1395           | 1984           | 1984             | 1984             | 1968           | 1968             | 1968           |
| Max. power, <sup>1</sup> PS at rpm                 | 150/5000-6000  | 190/4200-6000  | 190/4200-6000    | 252/5000-6000    | 150/3250-4200  | 150/3250-4200    | 150/3250-4200  |
| <b>Performance</b>                                 |                |                |                  |                  |                |                  |                |
| Max. torque, Nm at rpm                             | 250/1500-3500  | 320/1450-4200  | 320/1450-4200    | 370/1600-4500    | 320/1500-3250  | 320/1500-3250    | 320/1500-3250  |
| 0-62mph acceleration, seconds                      | 8.7            | 7.2            | 7.3              | 5.8              | 8.9            | 8.7              | 8.9            |
| Top speed, mph                                     | 130            | 149            | 149              | 155              | 130            | 130              | 137            |
| <b>Weight</b>                                      |                |                |                  |                  |                |                  |                |
| Unladen weight, <sup>2</sup> kg                    | 1320           | 1380           | 1405             | 1510             | 1430           | 1470             | 1430           |
| Gross weight limit, kg                             | 1890           | 1960           | 1985             | 2080             | 2030           | 2070             | 2030           |
| <b>Further information</b>                         |                |                |                  |                  |                |                  |                |
| Roof load limit/nose weight                        | 90/80          | 90/80          | 90/80            | 90/80            | 90/80          | 90/80            | 90/80          |
| Max trailer load unbraked <sup>3</sup>             | 690            | 720            | 740              | 750              | 750            | 750              | 750            |
| Max trailer load with 12%/8% gradient <sup>3</sup> | 1400/1600      | 1500/1700      | 1500/1700        | 1700/1900        | 1400/1600      | 1400/1600        | 1700/1900      |
| Fuel tank approx capacity, litres                  | 54             | 54             | 54               | 58               | 40             | 40               | 40             |
| AdBlue® tank approx capacity, litres               | n/a            | n/a            | n/a              | n/a              | 12             | 12               | 12             |
| ABI insurance group 1-50 <sup>4</sup>              | TBC            | TBC            | TBC              | TBC              | TBC            | TBC              | TBC            |

\*ultra TDI models come with low rolling resistance tyres.

<sup>1</sup>The given value was obtained in accordance with the specified measurement procedure (the respective current version of the Directive 80/1269/EEC). The maximum power output figures are quoted in PS (or Pferdestärke, which is the metric equivalent of brake horsepower). To convert to brake horsepower, divide the PS figure by 1.0139.

| Diesel           |                |                  |                |                  |                  |                  |                    |                    |
|------------------|----------------|------------------|----------------|------------------|------------------|------------------|--------------------|--------------------|
| 2.0 TDI          | 2.0 TDI ultra* | 2.0 TDI ultra*   | 2.0 TDI        | 2.0 TDI          | 2.0 TDI quattro  | 3.0 V6 TDI       | 3.0 V6 TDI quattro | 3.0 V6 TDI quattro |
| 7-speed S tronic | 6-speed manual | 7-speed S tronic | 6-speed manual | 7-speed S tronic | 7-speed S tronic | 7-speed S tronic | 7-speed S tronic   | 8-speed tiptronic  |
| 4-cylinder       | 4-cylinder     | 4-cylinder       | 4-cylinder     | 4-cylinder       | 4-cylinder       | 6-cylinder       | 6-cylinder         | 6-cylinder         |
| 1968             | 1968           | 1968             | 1968           | 1968             | 1968             | 2967             | 2967               | 2967               |
| 150/3250-4200    | 190/3800-4200  | 190/3800-4200    | 190/3800-4200  | 190/3800-4200    | 190/3800-4200    | 218/4000-5000    | 218/4000-5000      | 272/3250-4250      |
| 320/1500-3250    | 400/1750-3000  | 400/1750-3000    | 400/1750-3000  | 400/1750-3000    | 400/1750-3000    | 400/1250-3750    | 400/1250-3750      | 600/1500-3000      |
| 8.7              | 7.7            | 7.7              | 7.7            | 7.7              | 7.2              | 6.6              | 6.3                | 5.3                |
| 136              | 130            | 130              | 149            | 147              | 146              | 155              | 155                | 155                |
| 1465             | 1430           | 1470             | 1450           | 1480             | 1575             | 1540             | 1620               | 1660               |
| 2065             | 2040           | 2070             | 2045           | 2075             | 2160             | 2110             | 2190               | 2230               |
| 90/80            | 90/80          | 90/80            | 90/80          | 90/80            | 90/80            | 90/80            | 90/80              | 90/80              |
| 750              | 750            | 750              | 750            | 750              | 750              | 750              | 750                | 750                |
| 1700/1900        | 1400/1600      | 1400/1600        | 1700/1900      | 1700/1900        | 1800/2000        | 1700/1900        | 1800/2000          | 1900/2100          |
| 40               | 40             | 40               | 40             | 40               | 58               | 54               | 58                 | 58                 |
| 12               | 12             | 12               | 12             | 12               | 24               | 24               | 24                 | 24                 |
| TBC              | TBC            | TBC              | TBC            | TBC              | TBC              | TBC              | TBC                | TBC                |

<sup>2</sup>Vehicle's unladen weight without driver (calculated in accordance with the current version of Directive (80/1268/EEC).The fitting of additional equipment may increase the vehicle's unladen weight and drag coefficient, whereupon the potential carrying capacity and top speed will be correspondingly reduced. <sup>3</sup>The engine's power output always goes down with increasing altitude. At 1,000m above sea level, and for every additional 1,000m, deduct 10% from the weight of the outfit (trailer load limit + gross weight of the towing vehicle).<sup>4</sup>Highest insurance group rating shown. Group may be lower dependent on trim level. Please visit [www.thatcham.org/abigrouprating](http://www.thatcham.org/abigrouprating) for details.

# A4 Saloon technical data

Depending on your chosen A4 wheel size, different efficiency figures for CO<sub>2</sub> emissions and fuel consumption will apply (based on EU directive no. 715/2007 effective 01/09/14). This table is a quick reference guide to assist you in finding the correct values based on wheel sizes and your chosen engine.

|  |            | Petrol         |                |                  |                  | Diesel         |                  |                |
|--|------------|----------------|----------------|------------------|------------------|----------------|------------------|----------------|
| Engine   |            | 1.4 TFSI       | 2.0 TFSI       | 2.0 TFSI         | 2.0 TFSI quattro | 2.0 TDI ultra* | 2.0 TDI ultra*   | 2.0 TDI        |
| Transmission   |            | 6-speed manual | 6-speed manual | 7-speed S tronic | 7-speed S tronic | 6-speed manual | 7-speed S tronic | 6-speed manual |
| Max. power, <sup>1</sup> PS at rpm                       |            | 150/5000-6000  | 190/4200-6000  | 190/4200-6000    | 252/5000-6000    | 150/3250-4200  | 150/3250-4200    | 150/3250-4200  |
| Wheel and Tyre Clustering                                |            |                |                |                  |                  |                |                  |                |
| CO <sub>2</sub> emissions, <sup>2</sup> g/km             | 17" wheels | 126            | 127            | 116              | 136              | 99             | 101              | n/a            |
|  | 18" wheels | 128            | 130            | 119              | 141              | n/a            | n/a              | 106            |
|  | 19" wheels | 131            | 134            | 122              | 144              | n/a            | n/a              | 111            |
| Benefit in kind (BIK)%                                   | 17" wheels | 20%            | 20%            | 18%              | 22%              | 17%            | 18%              | n/a            |
|  | 18" wheels | 20%            | 21%            | 18%              | 23%              | n/a            | n/a              | 19%            |
|  | 19" wheels | 21%            | 21%            | 19%              | 23%              | n/a            | n/a              | 20%            |
| Fuel consumption, <sup>2</sup> mpg (l/100km) Urban       | 17" wheels | 41.5 (6.8)     | 39.2 (7.2)     | 44.1 (6.4)       | 36.7 (7.7)       | 62.8 (4.5)     | 60.1 (4.7)       | n/a            |
|  | 18" wheels | 40.9 (6.9)     | 38.7 (7.3)     | 42.8 (6.6)       | 36.2 (7.8)       | n/a            | n/a              | 58.9 (4.8)     |
|  | 19" wheels | 40.4 (7.0)     | 38.2 (7.4)     | 42.8 (6.6)       | 35.8 (7.9)       | n/a            | n/a              | 56.5 (5.0)     |
| Fuel consumption, <sup>2</sup> mpg (l/100km) Extra Urban | 17" wheels | 62.8 (4.5)     | 61.4 (4.6)     | 65.7 (4.3)       | 56.5 (5.0)       | 83.1 (3.4)     | 80.7 (3.5)       | n/a            |
|  | 18" wheels | 61.4 (4.6)     | 58.9 (4.8)     | 62.8 (4.5)       | 54.3 (5.2)       | n/a            | n/a              | 76.3 (3.7)     |
|  | 19" wheels | 58.9 (4.8)     | 56.5 (5.0)     | 60.1 (4.7)       | 52.3 (5.4)       | n/a            | n/a              | 72.4 (3.9)     |
| Fuel consumption, <sup>2</sup> mpg (l/100km) Combined    | 17" wheels | 53.3 (5.3)     | 50.4 (5.6)     | 55.4 (5.1)       | 47.9 (5.9)       | 74.3 (3.8)     | 72.4 (3.9)       | n/a            |
|  | 18" wheels | 52.3 (5.4)     | 49.6 (5.7)     | 53.3 (5.3)       | 45.6 (6.2)       | n/a            | n/a              | 70.6 (4.0)     |
|  | 19" wheels | 51.4 (5.5)     | 47.9 (5.9)     | 52.3 (5.4)       | 44.8 (6.3)       | n/a            | n/a              | 67.3 (4.2)     |

\*All TDI ultra engines come with 17" rolling resistance tyres.

<sup>1</sup>The given value was obtained in accordance with the specified measurement procedure (the respective current version of the Directive 80/1269/EEC). The maximum power output figures are quoted in PS (or Pferdestärke, which is the metric equivalent of brake horsepower). To convert to brake horsepower, divide the PS figure by 1.0139.

| Diesel           |                |                  |                |                  |                  |                  |                    |                    |
|------------------|----------------|------------------|----------------|------------------|------------------|------------------|--------------------|--------------------|
| 2.0 TDI          | 2.0 TDI ultra* | 2.0 TDI ultra*   | 2.0 TDI        | 2.0 TDI          | 2.0 TDI quattro  | 3.0 V6 TDI       | 3.0 V6 TDI quattro | 3.0 V6 TDI quattro |
| 7-speed S tronic | 6-speed manual | 7-speed S tronic | 6-speed manual | 7-speed S tronic | 7-speed S tronic | 7-speed S tronic | 7-speed S tronic   | 8-speed tiptronic  |
| 150/3250-4200    | 190/3800-4200  | 190/3800-4200    | 190/3800-4200  | 190/3800-4200    | 190/3800-4200    | 218/4000-5000    | 218/4000-5000      | 272/3250-4250      |
| n/a              | 102            | 103              | n/a            | n/a              | 114              | 109              | 115                | n/a                |
| 109              | n/a            | n/a              | 113            | 111              | 118              | 114              | 119                | 134                |
| 112              | n/a            | n/a              | 118            | 113              | 121              | 117              | 123                | 137                |
| n/a              | 18%            | 18%              | n/a            | n/a              | 20%              | 19%              | 21%                | n/a                |
| 19%              | n/a            | n/a              | 20%            | 20%              | 21%              | 20%              | 21%                | 24%                |
| 20%              | n/a            | n/a              | 21%            | 20%              | 22%              | 21%              | 22%                | 25%                |
| n/a              | 58.9 (4.8)     | 60.1 (4.7)       | n/a            | n/a              | 55.4 (5.1)       | 58.9 (4.8)       | 58.9 (4.8)         | n/a                |
| 56.5 (5.0)       | n/a            | n/a              | 54.3 (5.2)     | 57.6 (4.9)       | 54.3 (5.2)       | 58.9 (4.8)       | 58.9 (4.8)         | 51.4 (5.5)         |
| 55.4 (5.1)       | n/a            | n/a              | 52.3 (5.4)     | 56.5 (5.0)       | 53.3 (5.3)       | 57.6 (4.9)       | 57.6 (4.9)         | 50.4 (5.6)         |
| n/a              | 80.7 (3.5)     | 80.7 (3.5)       | n/a            | n/a              | 70.6 (4.0)       | 70.6 (4.0)       | 65.7 (4.3)         | n/a                |
| 74.3 (3.8)       | n/a            | n/a              | 72.4 (3.9)     | 74.3 (3.8)       | 68.9 (4.1)       | 68.9 (4.1)       | 64.2 (4.4)         | 58.9 (4.8)         |
| 72.4 (3.9)       | n/a            | n/a              | 68.9 (4.1)     | 72.4 (3.9)       | 65.7 (4.3)       | 65.7 (4.3)       | 62.8 (4.5)         | 57.6 (4.9)         |
| n/a              | 72.4 (3.9)     | 70.6 (4.0)       | n/a            | n/a              | 64.2 (4.4)       | 67.3 (4.2)       | 64.2 (4.4)         | n/a                |
| 67.3 (4.2)       | n/a            | n/a              | 64.2 (4.4)     | 67.3 (4.2)       | 62.8 (4.5)       | 64.2 (4.4)       | 61.4 (4.6)         | 55.4 (5.1)         |
| 65.7 (4.3)       | n/a            | n/a              | 62.8 (4.5)     | 65.7 (4.3)       | 61.4 (4.6)       | 62.8 (4.5)       | 60.1 (4.7)         | 54.3 (5.2)         |

<sup>2</sup>Fuel consumption and CO<sub>2</sub> emissions figures are obtained under standardised test conditions (Directive 93/116/EEC) using a representative model. This allows direct comparison between different models from different manufacturers, but may not represent the actual fuel consumption achieved in 'real world' driving conditions. More information is available at [www.dft.gov.uk/vca](http://www.dft.gov.uk/vca)

# A4 Avant technical data

## Key information about your car.

All of our A4 engines meet EU6 emissions standards. For Diesel engines, this means the addition of an AdBlue® tank to ensure compliance. The AdBlue® tank size for your engine is shown below and it may require a top-up between services.

|  | Petrol         |                |                  |                  | Diesel         |                  |                |
|--|----------------|----------------|------------------|------------------|----------------|------------------|----------------|
| Engine   | 1.4 TFSI**     | 2.0 TFSI       | 2.0 TFSI         | 2.0 TFSI quattro | 2.0 TDI ultra* | 2.0 TDI ultra*   | 2.0 TDI        |
| Transmission                                       | 6-speed manual | 6-speed manual | 7-speed S tronic | 7-speed S tronic | 6-speed manual | 7-speed S tronic | 6-speed manual |
| Cylinder   | 4-cylinder     | 4-cylinder     | 4-cylinder       | 4-cylinder       | 4-cylinder     | 4-cylinder       | 4-cylinder     |
| Displacement, cubic cm (valves per cylinder)       | 1395           | 1984           | 1984             | 1984             | 1968           | 1968             | 1968           |
| Max. power, <sup>1</sup> PS at rpm                 | 150/TBC        | 190/4200-6000  | 190/4200-6000    | 252/5000-6000    | 150/3250-4200  | 150/3250-4200    | 150/3250-4200  |
| <b>Performance</b>                                 |                |                |                  |                  |                |                  |                |
| Max. torque, Nm at rpm                             | 250/TBC        | 320/1450-4200  | 320/1450-4200    | 370/1600-4500    | 320/1500-3250  | 320/1500-3250    | 320/1500-3250  |
| 0-62mph acceleration, seconds                      | TBC            | 7.5            | 7.5              | 6.0              | 9.2            | 9.0              | 9.2            |
| Top speed, mph                                     | TBC            | 146            | 148              | 155              | 130            | 130              | 133            |
| <b>Weight</b>                                      |                |                |                  |                  |                |                  |                |
| Unladen weight, <sup>2</sup> kg                    | TBC            | 1430           | 1460             | 1540             | 1480           | 1525             | 1475           |
| Gross weight limit, kg                             | TBC            | 2030           | 2060             | 2130             | 2100           | 2145             | 2095           |
| <b>Further information</b>                         |                |                |                  |                  |                |                  |                |
| Roof load limit/nose weight                        | TBC            | 90/80          | 90/80            | 90/80            | 90/80          | 90/80            | 90/80          |
| Max trailer load unbraked <sup>3</sup>             | TBC            | 750            | 750              | 750              | 750            | 750              | 750            |
| Max trailer load with 12%/8% gradient <sup>3</sup> | TBC            | 1500/1700      | 1500/1700        | 1700/1900        | 1400/1600      | 1400/1600        | 1700/1900      |
| Fuel tank approx capacity, litres                  | TBC            | 54             | 54               | 58               | 40             | 40               | 40             |
| AdBlue® tank approx capacity, litres               | n/a            | n/a            | n/a              | n/a              | 12             | 12               | 12             |
| ABI insurance group 1-50 <sup>4</sup>              | TBC            | TBC            | TBC              | TBC              | TBC            | TBC              | TBC            |

\*ultra TDI models come with low rolling resistance tyres.

\*\* Vehicles due to arrive April 2016, data will be available closer to launch.

<sup>1</sup>The given value was obtained in accordance with the specified measurement procedure (the respective current version of the Directive 80/1269/EEC). The maximum power output figures are quoted in PS (or Pferdestärke, which is the metric equivalent of brake horsepower). To convert to brake horsepower, divide the PS figure by 1.0139.

| Diesel           |                |                  |                |                  |                  |                  |                    |                    |
|------------------|----------------|------------------|----------------|------------------|------------------|------------------|--------------------|--------------------|
| 2.0 TDI          | 2.0 TDI ultra* | 2.0 TDI ultra*   | 2.0 TDI**      | 2.0 TDI          | 2.0 TDI quattro  | 3.0 V6 TDI       | 3.0 V6 TDI quattro | 3.0 V6 TDI quattro |
| 7-speed S tronic | 6-speed manual | 7-speed S tronic | 6-speed manual | 7-speed S tronic | 7-speed S tronic | 7-speed S tronic | 7-speed S tronic   | 8-speed tiptronic  |
| 4-cylinder       | 4-cylinder     | 4-cylinder       | 4-cylinder     | 4-cylinder       | 4-cylinder       | 6-cylinder       | 6-cylinder         | 6-cylinder         |
| 1968             | 1968           | 1968             | 1968           | 1968             | 1968             | 2967             | 2967               | 2967               |
| 150/3250-4200    | 190/3800-4200  | 190/3800-4200    | 190/TBC        | 190/3800-4200    | 190/3800-4200    | 218/4000-5000    | 218/4000-5000      | 272/3250-4250      |
| 320/1500-3250    | 400/1750-3000  | 400/1750-3000    | 400/TBC        | 400/1750-3000    | 400/1750-3000    | 400/1250-3750    | 400/1250-3750      | 600/1500-3000      |
| 9.0              | 7.9            | 7.9              | TBC            | 7.9              | 7.4              | 6.7              | 6.4                | 5.4                |
| 132              | 130            | 130              | TBC            | 143              | 143              | 152              | 152                | 155                |
| 1525             | 1575           | 1530             | TBC            | 1530             | 1615             | 1595             | 1660               | 1695               |
| 2145             | 2120           | 2150             | TBC            | 2145             | 2220             | 2185             | 2250               | 2285               |
| 90/80            | 90/80          | 90/80            | TBC            | 90/80            | 90/80            | 90/80            | 90/80              | 90/80              |
| 750              | 750            | 750              | TBC            | 750              | 750              | 750              | 750                | 750                |
| 1700/1900        | 1400/1600      | 1400/1600        | TBC            | 1700/1900        | 1800/2000        | 1700/1900        | 1800/2000          | 1900/2100          |
| 40               | 40             | 40               | 40             | 40               | 58               | 54               | 58                 | 58                 |
| 12               | 12             | 12               | 12             | 12               | 24               | 24               | 24                 | 24                 |
| TBC              | TBC            | TBC              | TBC            | TBC              | TBC              | TBC              | TBC                | TBC                |

<sup>2</sup>Vehicle's unladen weight without driver (calculated in accordance with the current version of Directive (80/1268/EEC).The fitting of additional equipment may increase the vehicle's unladen weight and drag coefficient, whereupon the potential carrying capacity and top speed will be correspondingly reduced. <sup>3</sup>The engine's power output always goes down with increasing altitude. At 1,000m above sea level, and for every additional 1,000m, deduct 10% from the weight of the outfit (trailer load limit + gross weight of the towing vehicle).<sup>4</sup>Highest insurance group rating shown. Group may be lower dependent on trim level. Please visit [www.thatcham.org/abigrouprating](http://www.thatcham.org/abigrouprating) for details.

# A4 Avant technical data

Depending on your chosen A4 wheel size, different efficiency figures for CO<sub>2</sub> emissions and fuel consumption will apply (based on EU directive no. 715/2007 effective 01/09/14). This table is a quick reference guide to assist you in finding the correct values based on wheel sizes and your chosen engine.

|  |            | Petrol         |                |                  |                  | Diesel         |                  |                |
|--|------------|----------------|----------------|------------------|------------------|----------------|------------------|----------------|
| Engine   |            | 1.4 TFSI**     | 2.0 TFSI       | 2.0 TFSI         | 2.0 TFSI quattro | 2.0 TDI ultra* | 2.0 TDI ultra*   | 2.0 TDI        |
| Transmission   |            | 6-speed manual | 6-speed manual | 7-speed S tronic | 7-speed S tronic | 6-speed manual | 7-speed S tronic | 6-speed manual |
| Max. power, <sup>1</sup> PS at rpm                       |            | 150/TBC        | 190/4200-6000  | 190/4200-6000    | 252/5000-6000    | 150/3250-4200  | 150/3250-4200    | 150/3250-4200  |
| Wheel and Tyre Clustering                                |            |                |                |                  |                  |                |                  |                |
| CO <sub>2</sub> emissions, <sup>2</sup> g/km             | 17" wheels | TBC            | 129            | 121              | 139              | 104            | 104              | n/a            |
|  | 18" wheels | TBC            | 132            | 124              | 144              | n/a            | n/a              | 111            |
|  | 19" wheels | TBC            | 136            | 128              | 147              | n/a            | n/a              | 116            |
| Benefit in kind (BIK)%                                   | 17" wheels | TBC            | 20%            | 19%              | 22%              | 18%            | 18%              | n/a            |
|  | 18" wheels | TBC            | 21%            | 19%              | 23%              | n/a            | n/a              | 20%            |
|  | 19" wheels | TBC            | 22%            | 20%              | 24%              | n/a            | n/a              | 21%            |
| Fuel consumption, <sup>2</sup> mpg (l/100km) Urban       | 17" wheels | TBC            | 38.7 (7.3)     | 42.8 (6.6)       | 36.7 (7.7)       | 60.1 (4.7)     | 58.9 (4.8)       | n/a            |
|  | 18" wheels | TBC            | 38.2 (7.4)     | 42.2 (6.7)       | 36.2 (7.8)       | n/a            | n/a              | 56.5 (5.0)     |
|  | 19" wheels | TBC            | 37.7 (7.5)     | 41.5 (6.8)       | 35.8 (7.9)       | n/a            | n/a              | 55.4 (5.1)     |
| Fuel consumption, <sup>2</sup> mpg (l/100km) Extra Urban | 17" wheels | TBC            | 60.1 (4.7)     | 62.8 (4.5)       | 55.4 (5.1)       | 78.5 (3.6)     | 78.5 (3.6)       | n/a            |
|  | 18" wheels | TBC            | 58.9 (4.8)     | 58.9 (4.8)       | 52.3 (5.4)       | n/a            | n/a              | 74.3 (3.8)     |
|  | 19" wheels | TBC            | 55.4 (5.1)     | 57.6 (4.9)       | 51.4 (5.5)       | n/a            | n/a              | 70.6 (4.0)     |
| Fuel consumption, <sup>2</sup> mpg (l/100km) Combined    | 17" wheels | TBC            | 50.4 (5.6)     | 53.3 (5.3)       | 46.3 (6.1)       | 70.6 (4.0)     | 70.6 (4.0)       | n/a            |
|  | 18" wheels | TBC            | 48.7 (5.8)     | 52.3 (5.4)       | 44.8 (6.3)       | n/a            | n/a              | 67.3 (4.2)     |
|  | 19" wheels | TBC            | 47.1 (6.0)     | 50.4 (5.6)       | 44.1 (6.4)       | n/a            | n/a              | 65.7 (4.3)     |

\*All TDI ultra engines come with 17" rolling resistance tyres. \*\*Vehicles due to arrive April 2016, data will be available closer to launch.

<sup>1</sup>The given value was obtained in accordance with the specified measurement procedure (the respective current version of the Directive 80/1269/EEC). The maximum power output figures are quoted in PS (or Pferdestärke, which is the metric equivalent of brake horsepower). To convert to brake horsepower, divide the PS figure by 1.0139.

| Diesel           |                |                  |                |                  |                  |                  |                    |                    |
|------------------|----------------|------------------|----------------|------------------|------------------|------------------|--------------------|--------------------|
| 2.0 TDI          | 2.0 TDI ultra* | 2.0 TDI ultra*   | 2.0 TDI**      | 2.0 TDI          | 2.0 TDI quattro  | 3.0 V6 TDI       | 3.0 V6 TDI quattro | 3.0 V6 TDI quattro |
| 7-speed S tronic | 6-speed manual | 7-speed S tronic | 6-speed manual | 7-speed S tronic | 7-speed S tronic | 7-speed S tronic | 7-speed S tronic   | 8-speed tiptronic  |
| 150/3250-4200    | 190/3800-4200  | 190/3800-4200    | 190/TBC        | 190/3800-4200    | 190/3800-4200    | 218/4000-5000    | 218/4000-5000      | 272/3250-4250      |
| n/a              | 106            | 106              | n/a            | n/a              | 116              | 114              | 119                | n/a                |
| 112              | n/a            | n/a              | TBC            | 113              | 120              | 117              | 122                | 139                |
| 115              | n/a            | n/a              | TBC            | 116              | 123              | 121              | 125                | 142                |
| n/a              | 19%            | 19%              | n/a            | n/a              | 21%              | 20%              | 21%                | n/a                |
| 20%              | n/a            | n/a              | TBC            | 20%              | 22%              | 21%              | 22%                | 25%                |
| 21%              | n/a            | n/a              | TBC            | 21%              | 22%              | 22%              | 23%                | 26%                |
| n/a              | 56.5 (5.0)     | 58.9 (4.8)       | n/a            | n/a              | 54.3 (5.2)       | 57.6 (4.9)       | 57.6 (4.9)         | n/a                |
| 55.4 (5.1)       | n/a            | n/a              | TBC            | 57.6 (4.9)       | 53.3 (5.3)       | 57.6 (4.9)       | 56.5 (5.0)         | 49.6 (5.7)         |
| 54.3 (5.2)       | n/a            | n/a              | TBC            | 56.5 (5.0)       | 52.3 (5.4)       | 56.5 (5.0)       | 56.5 (5.0)         | 48.7 (5.8)         |
| n/a              | 76.3 (3.7)     | 78.5 (3.6)       | n/a            | n/a              | 68.9 (4.1)       | 68.9 (4.1)       | 65.7 (4.3)         | n/a                |
| 72.4 (3.9)       | n/a            | n/a              | TBC            | 70.6 (4.0)       | 67.3 (4.2)       | 65.7 (4.3)       | 62.8 (4.5)         | 56.5 (5.0)         |
| 70.6 (4.0)       | n/a            | n/a              | TBC            | 68.9 (4.1)       | 64.2 (4.4)       | 62.8 (4.5)       | 61.4 (4.6)         | 55.4 (5.1)         |
| n/a              | 68.9 (4.1)     | 68.9 (4.1)       | n/a            | n/a              | 62.8 (4.5)       | 64.2 (4.4)       | 61.4 (4.6)         | n/a                |
| 65.7 (4.3)       | n/a            | n/a              | TBC            | 65.7 (4.3)       | 61.4 (4.6)       | 62.8 (4.5)       | 60.1 (4.7)         | 53.3 (5.3)         |
| 64.2 (4.4)       | n/a            | n/a              | TBC            | 64.2 (4.4)       | 60.1 (4.7)       | 61.4 (4.6)       | 58.9 (4.8)         | 52.3 (5.4)         |

<sup>2</sup>Fuel consumption and CO<sub>2</sub> emissions figures are obtained under standardised test conditions (Directive 93/116/EEC) using a representative model. This allows direct comparison between different models from different manufacturers, but may not represent the actual fuel consumption achieved in 'real world' driving conditions. More information is available at [www.dft.gov.uk/vca](http://www.dft.gov.uk/vca)

# A4 Saloon and Avant dimensions

## All the measurements you need.

See the exact dimensions of the all-new Audi A4 Saloon and Avant, so you can check everything – from whether the car fits your garage to whether your luggage fits the boot.

### A4 Saloon

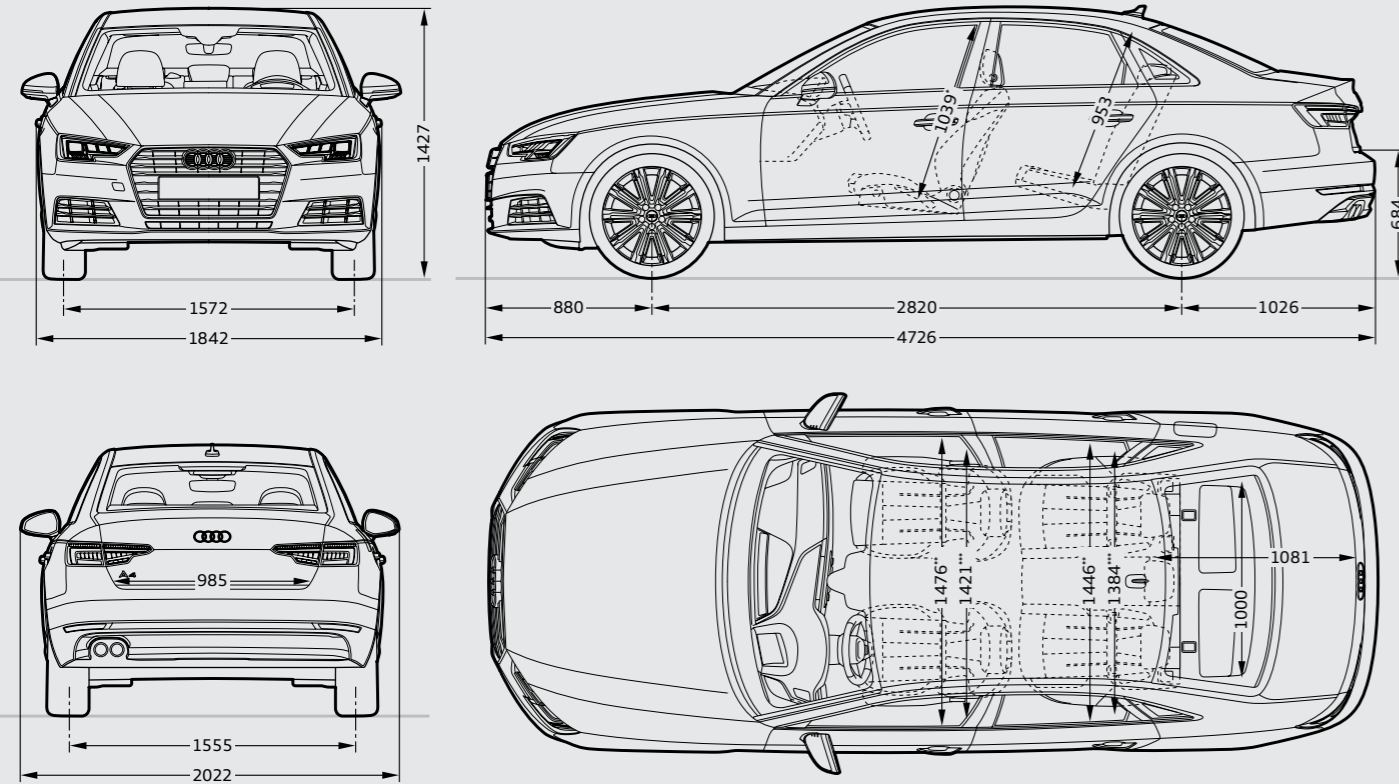

Saloon luggage compartment capacity:\*\*\*\*  
480l (rear seats up) or 965l (rear seats folded down).

### A4 Avant

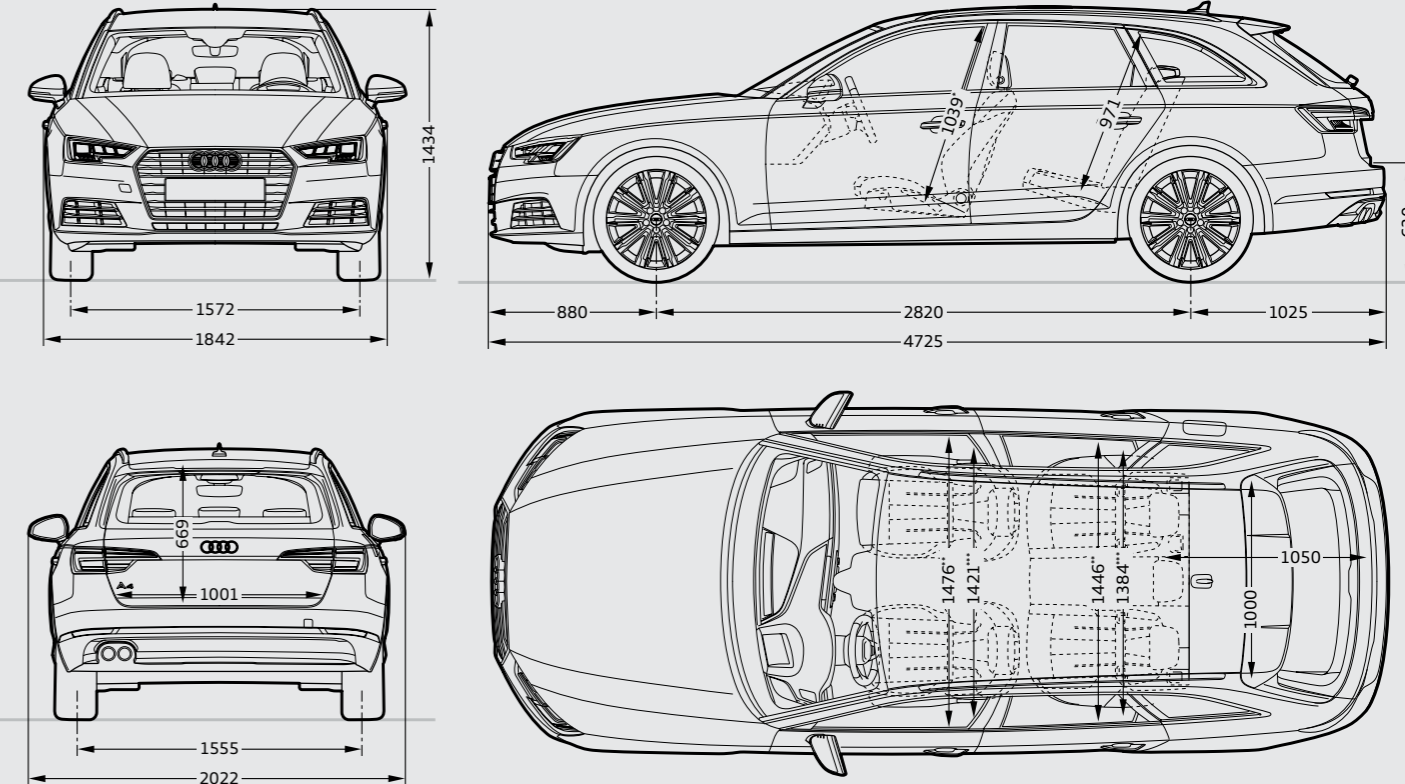

Avant luggage compartment capacity: \*\*\*\*  
505l (rear seats up) or 1510l (rear seats folded down).

# The Audi **Difference**

There's no single factor that makes an Audi Centre the right place to bring your car for servicing or maintenance. Really, it's the sum of many different parts. Together, we call them the Audi Difference.

## Servicing by Audi

Regular servicing is key to the smooth running of your Audi. We offer Audi service schedules designed with your car in mind. There are two main types: fixed, where servicing is due after a set time or mileage, and flexible, where sensors will monitor your driving style and alert you when a service is needed.

### Fixed Inspection Service Schedule

| Vehicle Usage      |  |
|--------------------|--|
| Mileage            | Less than 10,000 miles per annum. Mainly city/town centre driving. Short journeys. |
| Service Intervals  |  |
| Oil-Change Service | Fixed to every 9,000 <sup>1</sup> miles/1 year                                     |
| Inspection Service | Fixed to every 19,000 <sup>1</sup> miles/2 years                                   |

### Flexible Service Schedule

| Vehicle Usage      |   |
|--------------------|---|
| Mileage            | More than 10,000 miles per annum. Motorway and main road driving. Mainly longer distance journeys. Constant speeds. |
| Service Intervals  |   |
| Oil-Change Service | Variable to a maximum of every 19,000 <sup>1</sup> miles/2 years  |
| Inspection Service | Fixed to every 19,000 <sup>1</sup> miles/2 years  |

When a vehicle is frequently used in the following conditions, we recommend a Fixed Inspection Service Schedule, regardless of mileage: Uneconomical driving styles, e.g. heavy acceleration and braking, constant use of high revs. High engine-loading conditions, e.g. frequent towing and hill climbs. <sup>1</sup>As indicated by the service interval display. Mileages are approximate as the Service Indicator system uses kilometres as its distance measurement. <sup>2</sup>Subject to availability. <sup>3</sup>Excludes wear and tear.

## Everything you need

Book a 'service while you wait' appointment, or leave your car with us and take advantage of a courtesy car,<sup>2</sup> which we can even deliver to you. We will also ensure your car is returned to you with a full valet.

## Genuine parts, genuine prices

When we work on your car, we'll only use Audi Genuine Parts, which come with a 2-year guarantee.<sup>3</sup> So you know they'll be of the same high standards as the originals.

## We'll keep you updated

Whenever we see your Audi, we'll connect it directly to our headquarters in Ingolstadt for the latest software updates. These can be applied immediately, enhancing everything from your car's efficiency to the precision of its parking system.

## Audi Roadside Assistance

For even more reassurance, your Audi comes with 3 years' complimentary roadside assistance provided by the Automobile Association Insurance Services Limited. It means you'll be covered across the UK and throughout Europe in the unlikely event of a breakdown.

# Financing your Audi A4

## A range of finance plans designed to suit you.

At Audi, we don't just offer help to finance your new Audi A4 – we also offer value when it comes to keeping your new A4 maintained to the highest Audi standards. With most finance agreements, you just need to choose your annual mileage and the length of the term, then pay an initial deposit which could be as little as one monthly payment. For more details, see the accompanying Audi Finance booklet, or speak to your local Audi Centre.

## Solutions Personal Contract Plan

A flexible finance plan designed to give you a number of options, making it ideal if you want to change your car more regularly. At the end of the agreement, you have three choices:

1. Exchange the car for a new Audi.
2. Pay the option to purchase fee and optional final payment, then take full ownership of the car.
3. Simply return the car to Audi (fees may be payable).

## Hire Purchase

If you know you'd like to keep your Audi, Hire Purchase could be right for you. And as you're making your payments with a view to owning the car, there's no restriction on how far you can drive each year.

## Contract Hire

If you don't want to own your Audi, Contract Hire could be a great option. You can add a service, maintenance and tyres plan and, for VAT-registered businesses, an element of the VAT on rentals may be recoverable. You simply need to commit to a regular monthly payment and hand your car back at the end of your agreement (subject to our return standards).

## Online finance calculator

To get an idea of your repayments on a finance scheme, enter a few details online at [audi.co.uk](http://audi.co.uk) and you'll see what you can expect to pay for your new Audi.

## Audi Complete

Audi Complete is simply a way to look after the servicing and maintenance costs for your Audi in a single package. You pay a one-off or monthly fee and we'll cover all your servicing, maintenance and tyres for the next three years, including your MOT. Or if you prefer, you can opt for our 'service only' or 'service and maintenance' packages.

## Audi Insurance

We want you to start enjoying your new car from day one and, thanks to Audi complimentary five-day insurance,\* you can. To activate it, simply call 0330 303 6900, give us a few details and you can drive it away as soon as you take delivery.

Telephone lines are open Monday to Friday 8am-8pm, and Saturday 9am-4pm. For details of our full range of insurance products, visit [insurewithaudi.co.uk](http://insurewithaudi.co.uk)

\*Subject to eligibility criteria. Audi Motor Insurance is sold and administered by Ageas Retail Limited. Audi Financial Services is a trading name of Volkswagen Financial Services (UK) Limited ("VWFS UK"). Registered in England and Wales No. 2835230. Registered Office: Brunswick Court, Yeomans Drive, Blakelands, Milton Keynes MK14 5LR. Financial and consumer credit services are provided by VWFS UK. Volkswagen Financial Services (UK) Limited is authorised and regulated by the Financial Conduct Authority, registration number 311988. Audi Motor Insurance from Audi Financial Services is sold and administered by Ageas Retail Limited, registered in England and Wales No. 1324965. Registered office: Ageas House, Hampshire Corporate Park, Templars Way, Eastleigh, Hampshire SO53 3YA. Ageas Retail Limited is authorised and regulated by the Financial Conduct Authority (FCA), registration number 312468. Volkswagen Financial Services (UK) and Ageas Retail Limited are not part of the same corporate group.

# Important information

## Welcome to Audi.

By placing an order for your Audi, you're choosing to get behind the wheel of one of the most sophisticated cars on the road. And because we believe the service we offer should be just as advanced, we want to let you know exactly what you can expect from us, now and in the future.

### Audi Centres

We guarantee that all our Centres will be open as follows:

Sales: Monday to Friday 9am–6pm  
Saturday 9am–5pm

Service: Monday to Friday 8am–6pm  
Saturday 8.30am–1pm

Sunday opening is at local discretion.

### Audi customer care

Every new Audi includes these reassuring features as standard:

- ▶ 3-year Audi warranty (unlimited mileage in the first two years, with a full mechanical and electrical warranty up to 60,000 miles in the third year)
- ▶ A 3-year paint warranty
- ▶ A 12-year anti-corrosion warranty
- ▶ 3 year' UK roadside assistance and recovery
- ▶ 3-year Accessories warranty on any accessories purchased with your car (2-year warranty if purchased separately from your new Audi)

You also have the option when ordering your new car of choosing a 4-year or 5-year Audi warranty. Speak to a member of the sales team for more information.

### Our environmental commitment

We promise to dispose of all non-biodegradable materials from your vehicle in a responsible manner.

### Our prices

We've done all we can to make the prices you see in this guide accurate at the time of printing. However, as our products are constantly being updated, we recommend checking the details with your Audi Centre. All prices shown in this guide include VAT which is currently charged at 20%. Delivery charges and number plates are not included in the standard vehicle price.

|                 |         |
|-----------------|---------|
| Delivery charge | £504.99 |
| Number plate    | £20.00  |
| VAT             | £105.01 |
| Total           | £630.00 |

Recommended On-The-Road (OTR) prices include the delivery and number plate charges above, Road Fund Licence (which may vary depending on model/transmission – see table for details) and first registration fee at £55.00.

### Delivering your new car

As we build your car, we'll keep you updated on its progress. And once it's finished, subject to reasonable notice, we'll deliver it to a place of your choice, whether that's your home or work.

### Audi tax-free sales

If you are entitled to purchase a vehicle free of VAT, normally through military or diplomatic privilege, please contact your local Audi Centre for full details. Should you have any difficulty obtaining the information you require, please call 0870 241 5663.

### Audi Connect

In order to use Audi Connect you will require a separate SIM card with data option (which can be inserted into the included SIM card reader). If LTE usage is required, the SIM card will also need an LTE option. When a separate SIM card is used, hands-free phone calls are possible by connecting a different mobile telephone via Bluetooth Hands Free Profile.

Online services will only be available within the coverage of the mobile phone network; there may be additional costs for the use of these services (charges and billing correspond to the personal mobile phone contract or SIM card contract). Due to high data volumes, a mobile phone contract including an unlimited or high usage data plan is strongly recommended. The content and scope of the online based services offered may vary.

The Audi Connect services provided from vehicle delivery are available for at least one year. After 24 months from delivery of the vehicle, the term of the Audi Connect services will be extended free of charge once for 12 months.

Audi Connect enables access to the services of Google and Twitter. Permanent availability cannot be guaranteed as this is the responsibility of Google and Twitter. Please note that the services received are also dependent on the capability of your mobile phone.

Google and the Google logo are registered trademarks of Google Inc. The availability of services supporting Audi Connect varies from country to country.

### Online Map updates

The map version delivered can be updated with the first 5 updates which are issued at intervals of 6 months. The current navigation data can be downloaded from the myAudi platform at [audi.com/myaudi](http://audi.com/myaudi) and installed in the vehicle via SD card. In conjunction with Audi Connect, the update can be carried out online in the vehicle. In addition, it is possible to have the new navigation data installed by an Audi Centre at extra cost.

### CO2 data and information

#### CO2 emissions-based Vehicle Excise Duty.

Vehicle Excise Duty (Road Fund Licence) is based upon the amount of Carbon Dioxide (CO2) a vehicle emits, measured in grams per kilometre (g/km). First year VED rates apply to the first year of ownership. Annual VED rates apply thereafter. The DVLA has created thirteen categories:

| Petrol and Diesel engines | First year | Annual rate (second year onwards) |
|---------------------------|------------|-----------------------------------|
| A – up to 100g/km         | £0         | £0                                |
| B – 101 to 110g/km        | £0         | £20                               |
| C – 111 to 120g/km        | £0         | £30                               |
| D – 121 to 130g/km        | £0         | £110                              |
| E – 131 to 140g/km        | £130       | £130                              |
| F – 141 to 150g/km        | £145       | £145                              |
| G – 151 to 165g/km        | £180       | £180                              |
| H – 166 to 175g/km        | £295       | £205                              |
| I – 176 to 185g/km        | £350       | £225                              |
| J – 186 to 200g/km        | £490       | £265                              |
| K – 201 to 225g/km        | £640       | £290                              |
| L – 226 to 255g/km        | £870       | £490                              |
| M – over 255g/km          | £1100      | £505                              |

Vehicle Excise Duty (VED) rates correct at time of going to print, but these may alter to reflect any change in the applicable VED rate.



**Audi UK**  
Customer Services  
Selectapost 29  
Sheffield  
S97 3FG  
0800 699888  
audi.co.uk

Specifications and prices subject  
to change without notice.

© Audi (UK)

Printed in the UK  
Edition 0.3 10/15  
2016 Model Year

Images are for illustrative purposes only.  
Models shown are left-hand drive.